

Click here to send this document to your printer

CIA FOIA - Browse Document in Full

APPROVED FOR RELEASE
DATE: MAY 2006

ENCL TO
OXC-5503
COPY 1 OF 1

(b) (3)

1 - NRO-MK
2 NPIC

August 20, 1963

File OX
LOCKHEED A-12

Dear Jack :

The enclosed handbook is our present version of the instructions to pilots for use of our photographic equipment. I would appreciate your looking at it critically with regard to additions or deletions which we should make.

Because of the security nature of the contents of this Addendum, it will not be included as a regular part of the A12 Flight Handbook. It will be made available to operations and pilots for use in a secure fashion.

Please advise me as to who you believe should have copies of this Addendum and how many.

Best regards,



kld





OXC-3503
COPY OF

ADDENDUM
A-12 FLIGHT HANDBOOK
PHOTOGRAPHIC EQUIPMENT

Issued: February, 1963
Revised: August, 1963



SECURITY INFORMATION

Specific Instructions For Safeguarding This Information :

1. This document contains information affecting the national defense of the United States within the meaning of the Espionage Laws Title 18, USC Section 793 and 794. The transmission or the revelation of its contents in any manner to unauthorized persons is prohibited by law.

The nature of this document is such that dissemination and handling will be carried out with strict adherence to the following policies :

- a. Distribution will be controlled on a strict, officially established "need-to-know" basis.
 - b. Strict accountability of each document will be maintained.
 - c. This document will be controlled in such a fashion to prevent its loss, destruction, or falling into the hands of unauthorized persons.
2. In the event this document is lost or is subject to unauthorized disclosure or other possible subjection to compromise of classified information, such fact will be promptly reported to the authority responsible for the custody of the material for appropriate action.



TABLE OF CONTENTS

Paragraph	Title	Page
1-2	General Information	1
1-4	Type I - General	1
1-21	Type I - Operation	19
2-1	Type II - General	28
2-14	Type II - Operation	37
3-1	Type III - General	43
3-9	Type III - Operation	48



LIST OF ILLUSTRATIONS

Figure	Title	Page
1-1.	Camera Configuration Characteristics	2
1-2.	Aerial Panoramic Photography, Type I	4
1-3.	Ground Coverage Format, Straight and Level Flight, Type I	5
1-4.	Q-Bay Package Type I, Physical Description	6
1-5.	Q-Bay Package Type I, System Dimensions	7
1-6.	Type I Control Panel	10
1-7.	Q-Bay Type I and Article Attitude Relationships, Caged Condition	17
1-8.	Vehicle and Type I Attitude Relationships, Uncaged Condition	18
1-9.	Typical Type I Mission Profile	21
1-10.	Type I Package Frame Format Relationship To Ground Coverage Pattern	26
1-11.	Data Recording on Film	27
2-1.	Aerial Panoramic Photography, Type II	29
2-2.	Ground Coverage Format, Straight and Level Flight, Type II	30
2-3.	Q-Bay Package Type II Physical Description	32



LIST OF ILLUSTRATIONS (cont)

Figure	Title	Page
2-4.	Type II Control Panel	33
2-5.	Q-Bay Package Type II and Vehicle Attitude Relationships, Caged Condition	36
2-6.	Typical Type II Mission Profiles	39
2-7.	Type II Package Format Relationship to Ground Coverage Pattern	42
3-1.	Ground Coverage Format, Straight and Level Flight, Type III	44
3-2.	Q-Bay Package Type III Physical Description	46
3-3.	Type III Control Panel	47
3-4.	Typical Type III Mission Profiles	49



Revised : 7-29-63

ADDENDUM
A-12 FLIGHT HANDBOOK

1-1. PHOTOGRAPHIC EQUIPMENT.

1-2. General Information.

1-3. The primary payload of the airplane consists of various camera configurations. These different groupings are designated as Type I, Type II and Type III. Any one of these may be installed in the equipment bay aft of the cockpit, depending upon the selectivity of the operating command. The characteristics chart, Figure 1-1, provides data for each of the different configurations.

Three types of lower equipment bay hatches are provided with proper window locations and sizes for the corresponding camera configuration.

1-4. Type I - General.

1-5. The Type I equipment bay package is an aerial panoramic camera system with the mission of obtaining photographs of the earth from an airborne vehicle. The camera system photographs the earth transverse to the vehicle line of flight. Two optical systems within a single camera package (stable platform) are employed to accomplish the photography - a forward system and an aft system.



Config	Focal Length	Range-Photo Flight, N. M.	Area Coverage	Ground Resolution of NADIR	Ground Scale	Operating Time	Cycle Time	Modes of Operation
Type I	19 in.	2500 Stereo	Max. swath width 75 naut. miles	1 foot	1:4750	80 min.	4.8 sec.	134° sweep which is 67° each side of a vertical centerline
Type II	21 in.	3670 Stereo	Max. swath width 63 naut. miles	1.40 ft.	1:4300	130 min.	5.7 sec.	126° sweep which is 63° each side of a vertical centerline
Type III	36 in.	2940 Stereo	Max. swath width 55 naut. miles	1.80 ft.	1:2500	Mode 1 is 93 min.	7.0 sec.	Five position sweep, three position stereo
			Vertical photo 7.4 x 7.4 naut. miles			Mode 2 is 93 min.	7.0 sec.	Vertical only

FIGURE 1-1
CAMERA CONFIGURATION CHARACTERISTICS

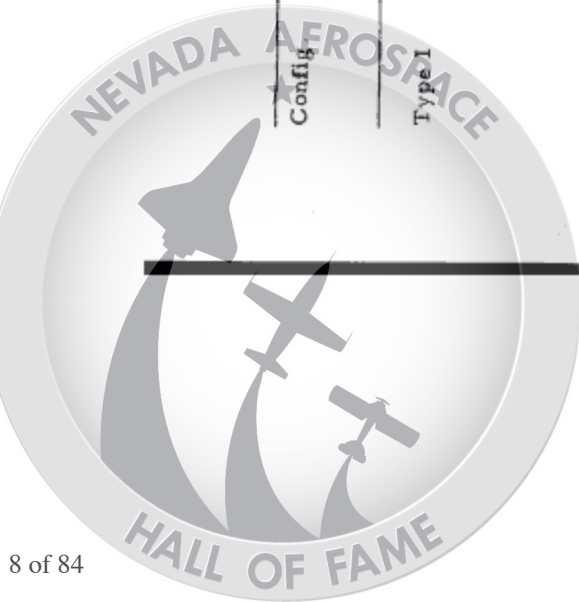

ADDENDUM

A-12 FLIGHT HANDBOOK

- 1-6. Photographic coverage of the camera system is represented in Figure 1-2. The forward optical system scans the earth from 67° to the left of nadir to 21° to the right of nadir. The aft optical system scans the earth from 21° to the left of nadir to 67° from the right of nadir. Each mission can provide 2500 nautical miles of flight line coverage on 1980 frames and 60 to 75 nautical miles (or 134°) total transverse coverage. The scan overlap provides full stereo viewing of mission results for all points on each frame format. See figure 1-3.
- 1-7. The package consists of two major assemblies -- a stable platform and a supporting frame assembly. See Figures 1-4 and 1-5. The stable platform is an aircraft type structure that contains both camera systems and associated subsystems, and the stabilization system. The stabilized platform is gimbal supported at its center of gravity through a gimbal support rod that is fixed to the frame assembly. The frame assembly is installed directly in the Q-Bay at four isolation shock mounts.



ADDENDUM
A-12 FLIGHT HANDBOOK

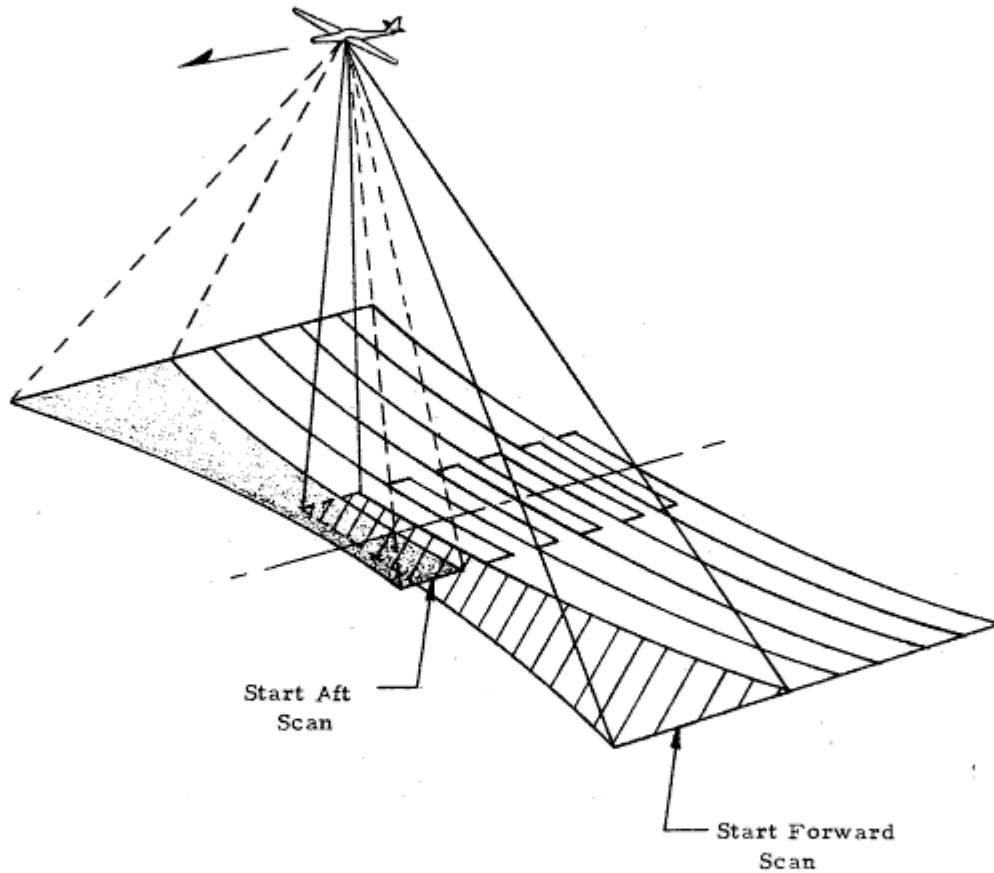

Figure 1-2. Aerial Panoramic Photography, Type I



ADDENDUM

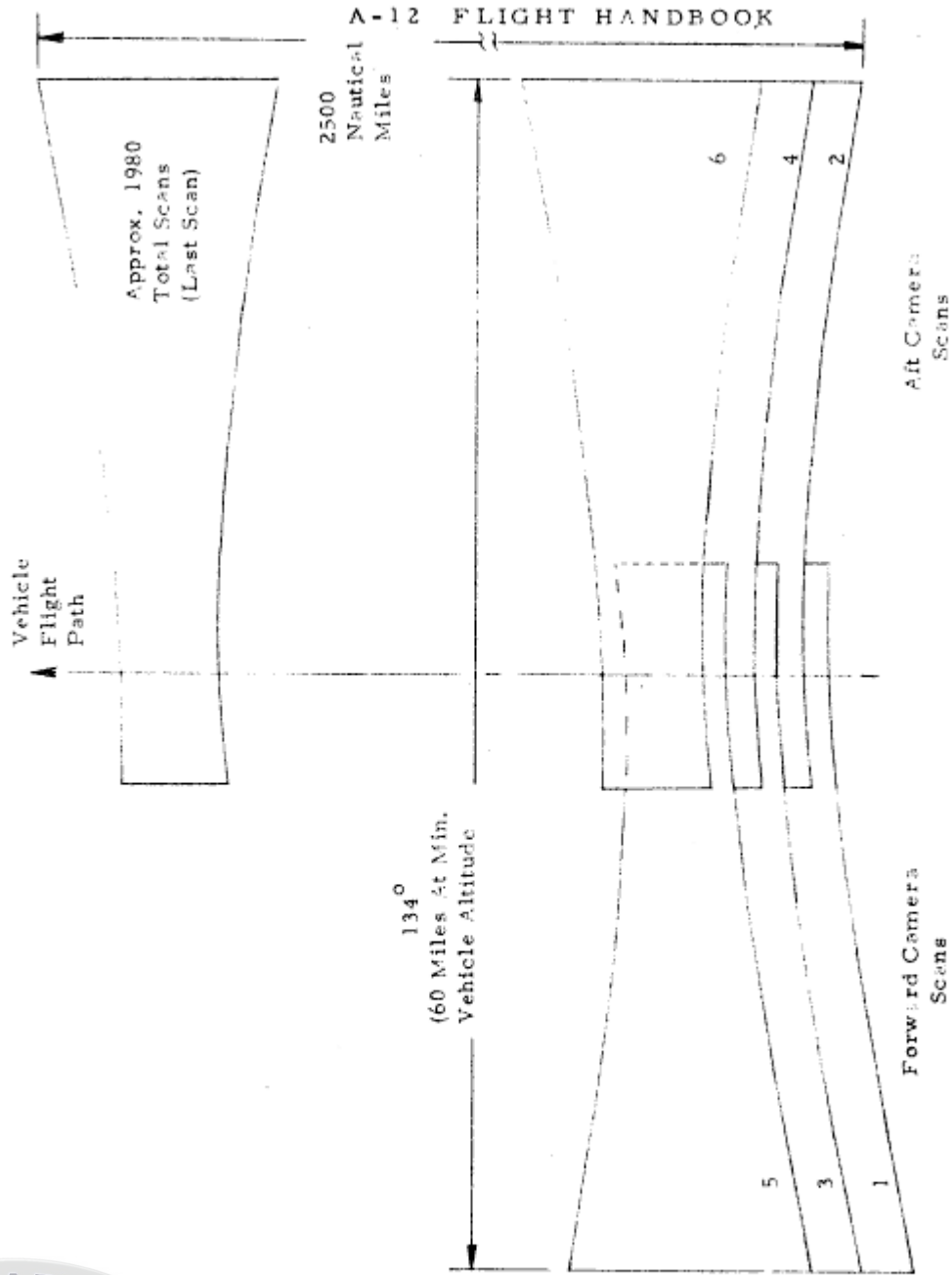

Figure 1-3. Ground Coverage Format, Straight And Level Flight, Type I



ADDENDUM
A-12 FLIGHT HANDBOOK

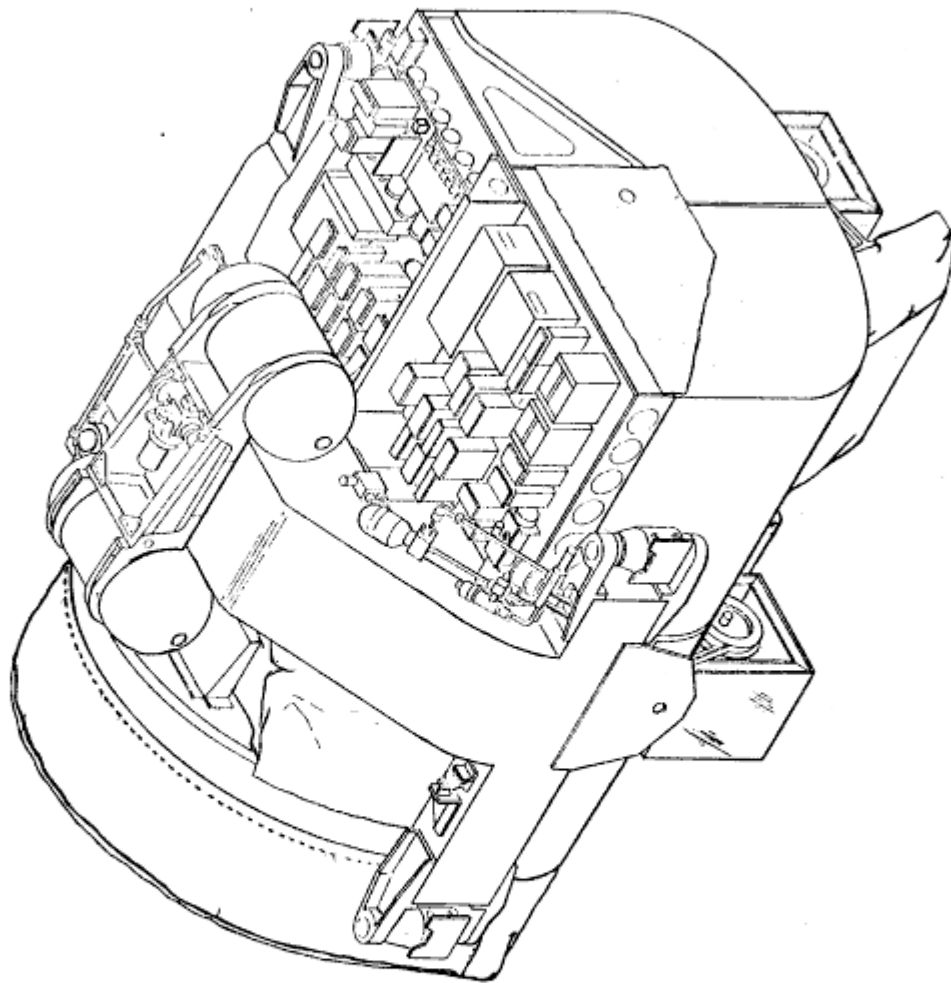

Figure 1-4. Q-Bay Package Type I, Physical Description



ADDENDUM

A-12 FLIGHT HANDBOOK

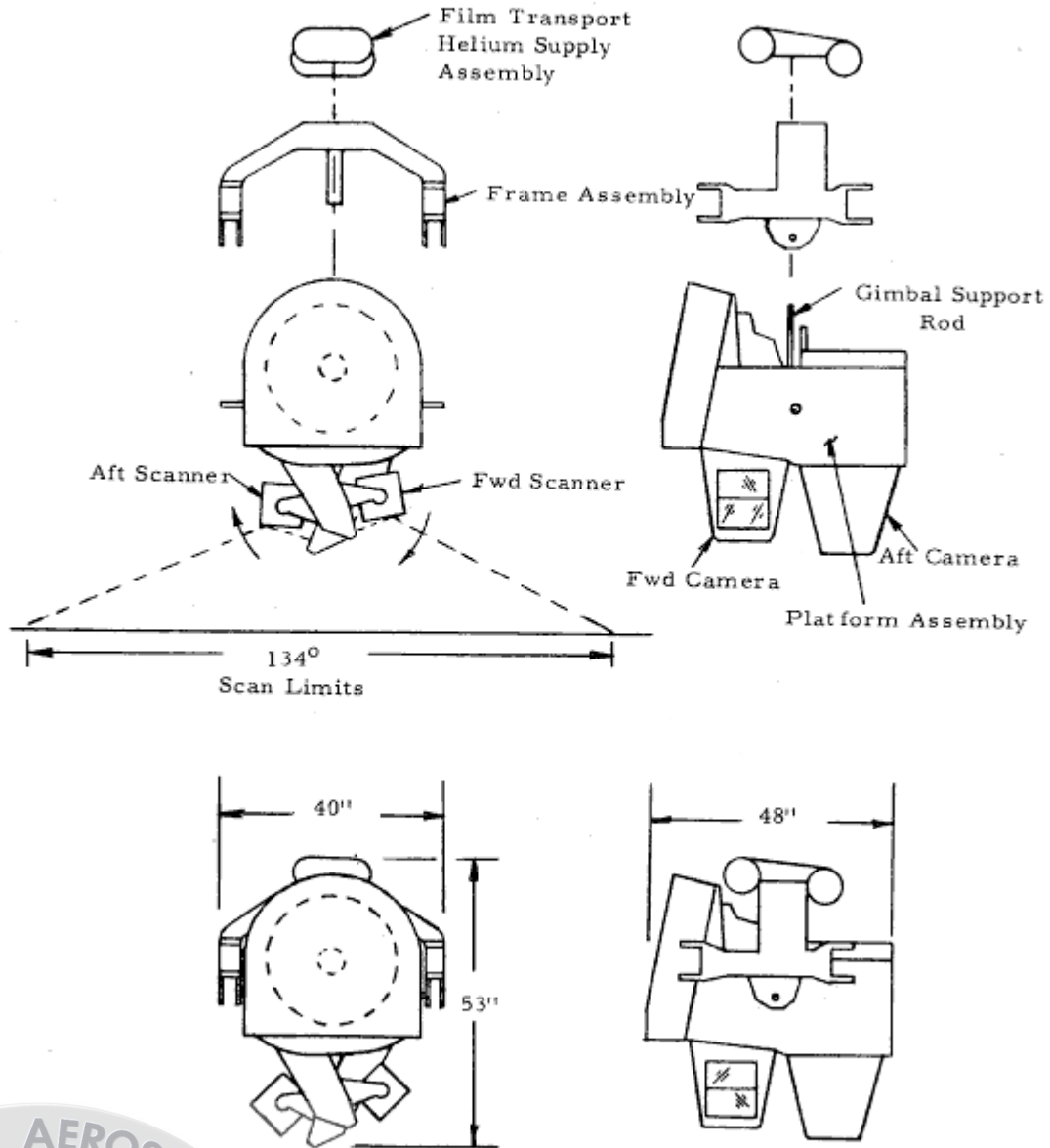
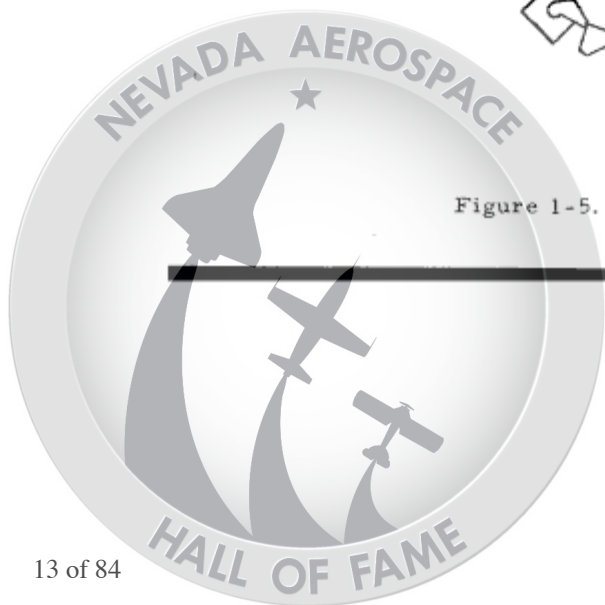

Figure 1-5. Q-Bay Package Type I, System Dimensions



ADDENDUM

A-12 FLIGHT HANDBOOK

- 1-8. The platform is normally in either one of two conditions -- caged or uncaged. In the caged condition, the platform is locked to the frame and therefore fixed with respect to the vehicle (except for 3/8" isolator freedom). In the uncaged condition, the platform is freely suspended from the gimbal support rod, and is allowed to stabilize with respect to rate and verticality. The caging system provides an effective means to quickly and automatically change the condition of the platform.
- 1-9. The control panel for the Type I package is shown in Figure 1-6. The control panel is located on the left cockpit console, and occupies an area approximately 6 inches by 3 inches.
- 1-10. The large STATUS selector switch, Figure 1-6, controls the operation of the package. The smaller V/H option selector switch controls the V/H input for camera functions. The TIMER - OFF toggle switch controls the data recording on the film and the automatic exposure control programmer. Three indicators are: CAGED (red), STBY 2 (amber), and OPR (green). Control panel switches and indicators are listed in Table I. Package failure is indicated by a Q-BAY EQUIPMENT OUT indicator (red) located on the warning light panel, center console.



ADDENDUM
A-12 FLIGHT HANDBOOK

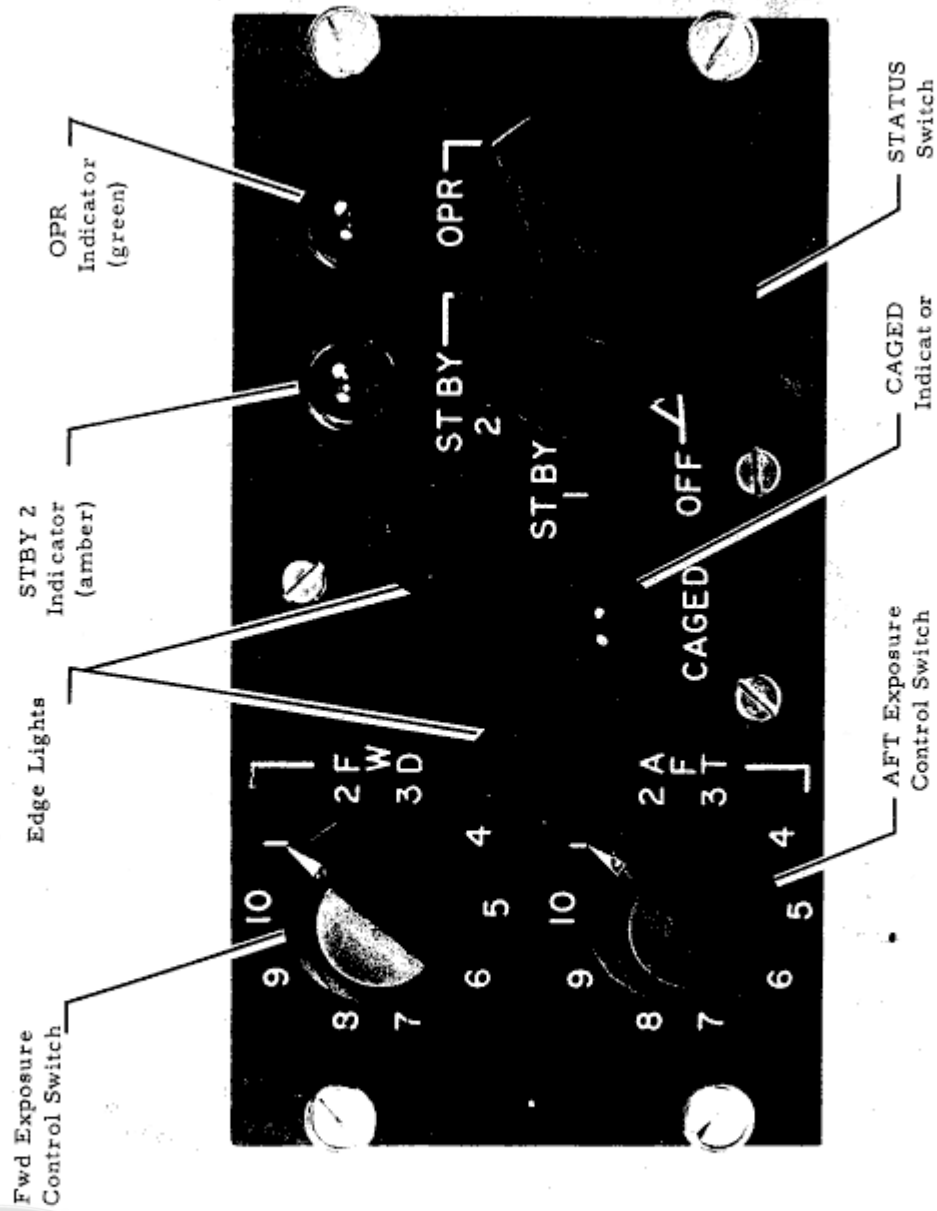

Figure 1-6. Type I Control Panel



CONTROL	POSITION	FUNCTION	INDICATORS
STATUS switch (4-position rotary selector switch)	OFF	Shuts down all systems in Type I package.	No indicators lighted on control panel.
	STBY 1 (scan idle mode and system warm-up mode)	Energizes scanner drives. Scanner cubes rotate at constant idle velocity to maintain even surface temperature due to thermal gradients. Data recording stepping motors are energized. Energizes system electronics for warmup of system to even temperatures and permits gyros to attain proper rpm.	No indicators lighted on control panel.
	STBY 2 (data flight recorder mode)	Turns on Magnetic Data Flight Recorder when first employed. Thereafter, identical to STBY 1.	CAGED (red) -- OFF STBY 2 (amber) -- ON OPERATE (green) -- OFF
	OPERATE (photography mode)	All system functions in operate condition. Photography takes place. Platform may be caged or uncaged.	CAGED (red) -- ON or OFF STBY 2 (amber) -- OFF OPERATE (green) -- ON
V/H OPTION (3 position selector switch)	SENSOR (V/H sensor)	Provides a corrected V/H signal for camera operation determined by scene viewed by V/H sensor.	Not Applicable.

TABLE 1. CONTROL PANEL CONTROLS AND INDICATORS

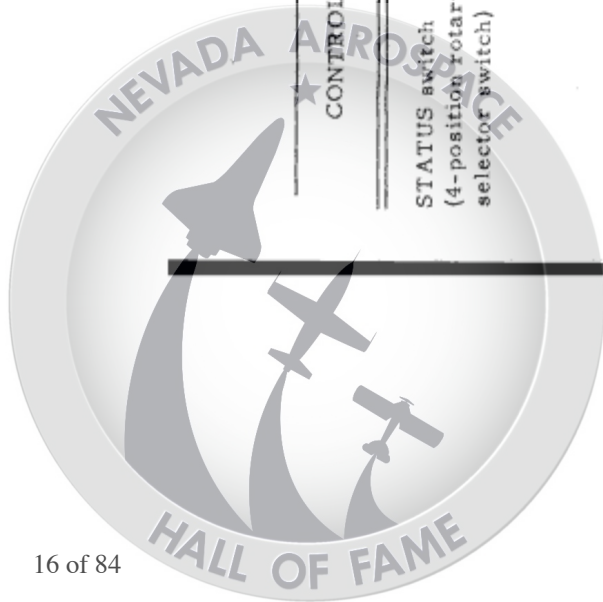

TABLE 1 (cont)

CONTROL	POSITION	FUNCTION	INDICATORS
	CL (clouds)	Switches out V/H sensor input and, therefore, provides an uncorrected nominal V/H signal for camera operation predetermined for a normal vehicle ground speed and nominal altitude above ground scene. Used during conditions of cloud cover to prevent false V/H information from controlling system operation.	Not applicable
	EMER (emergency)	Provides an uncorrected nominal V/H signal for camera operation predetermined for an emergency vehicle ground speed and emergency altitude above ground scene used in event of loss of one engine.	Not applicable
TIMER (2 Position toggle switch)	OFF	Prevents system exposure program tape and data from operating. Used during preflight system checks.	Not applicable
	TIMER	Turns on exposure programmer and allows data flasher to operate. (Data information will be recorded on film during OPERATE condition only.) Timer must be turned on at a preselected time, usually during refueling.	Not applicable



ADDENDUM

A-12 FLIGHT HANDBOOK

- 1-11. The STATUS switch is a 4 - position selector switch. Positions and functions are:
- a. STBY I position. This position energizes the forward and aft camera scanner drives, the gyro spin motors and all electronic subsystems for warmup. The scanner cubes are exposed to heat via the vehicle windows; as a result, the scanner optical elements may tend to expand. Thermal expansion of the optical elements is evenly maintained and possible deformation of the optical surface is prevented by having the scanner cubes rotate at a constant idle velocity prior to a mission run. This position also energizes the Type I package data recording mechanism stepping motors. The stepping motors must be synchronized with the INS inputs to reflect correct latitude, longitude and ground speed. The INS (Inertial Navigation System) and the data recording stepping motors are synchronized prior to take-off. At that time the data recording mechanism readouts follow INS signals. Data information, however, is not recorded on the film until the TIMER switch is placed to the TIMER position. The STBY I position of the STATUS switch also places critical system electronic packages in a warmup condition. The Type I package is a critically aligned assembly both mechanically and electronically. Thermal stabilization of all critical components is achieved for proper operation of the overall system by placing the STATUS switch in the STBY I mode prior to take-off. STBY I also energizes the gyro spin motors to allow time for them to reach proper rpm.



ADDENDUM

A-12 FLIGHT HANDBOOK

- b. STBY 2 position. The STBY 2 position energizes the magnetic data flight recorder and maintains all of the conditions determined by STBY 1. The flight recorder tapes critical system functions for post flight evaluation of overall system operation. The STBY 2 position thus maintains the magnetic data flight recorder in operation during intermittent operation of the Type I equipment.
- c. OPR position. The OPR (operate) position of the STATUS switch places the package in the photography mode. When the STATUS switch is placed in OPR, the following events normally occur:
- (1). The system "starts up". The green indicator light comes on. Film is transported through each camera, all phasing and synchronism of components occur, and photography takes place. Time from initial start-up to normal operating speed requires approximately 1 1/2 minutes.
 - (2). The system will uncage if the vehicle attitude is within discrete altitude limits. The red caged indicator will not light.
- or
- (3). The system will remain caged if the vehicle attitude is not within discrete attitude limits. The red indicator will light.
- d. OFF position. The OFF position of the STATUS switch shuts down the entire Type I package.

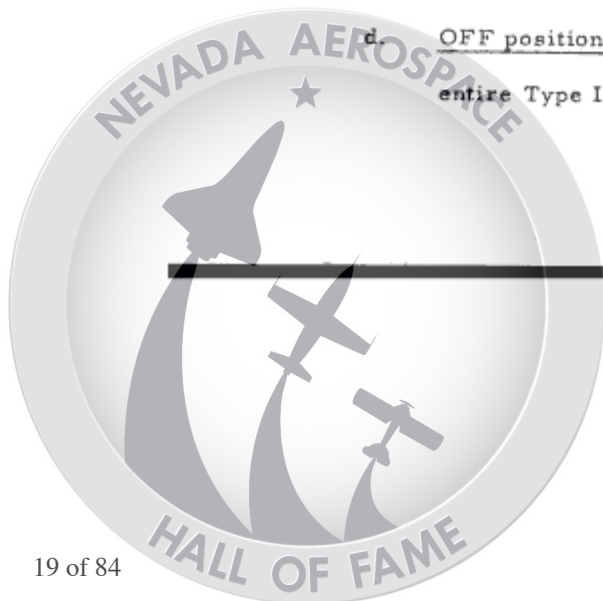

ADDENDUM

A-12 FLIGHT HANDBOOK

CAUTION

The OFF position is equipped with a special detent to prevent accidental placement to the OFF position. The STATUS switch must be simultaneously pushed in and turned in order to place switch from STBY 1 to OFF position.

- 1-12. V/H Option Switch. The V/H option switch controls the V/H inputs to the camera system. Three types of V/H inputs are provided for three different flight conditions. These are:
- a. SENSOR position. The SENSOR position is the normal position for the V/H OPTION switch. This position is selected during normal flight conditions and cloudless weather conditions.
 - b. CL (clouds) position. The CL (clouds) position is selected during normal flight conditions where partial cloud cover intermittently obstructs the ground scene.
 - c. EMER (emergency) position. The EMER (emergency) position is selected during abnormal flight conditions when one vehicle engine is out and an emergency vehicle altitude is necessary.



ADDENDUM

A-12 FLIGHT HANDBOOK

- 1-13. TIMER switch. The timer toggle switch controls the data flasher and the camera exposure programmer. The main purpose of the timer is to permit the operator to control the operation of the exposure programmer during a mission and thus assure that camera operation during preflight checks will not inadvertently cause the data chamber to record the operational base coordinates on the film.

NOTE

The Data Flasher can operate only when the TIMER switch is in the TIMER position and the STATUS switch is in the OPR position. The Exposure Programmer will operate when the TIMER switch is in the TIMER position and the STATUS switch is in STBY 1, STBY 2 or OPR position.

- 1-14. The Type I package is dynamically influenced by the vehicle under normal conditions in two ways:

- (1). Power inputs
- (2). Vehicle attitude

The package normally derives its power from inverter number 2. Power requirements and input configurations are such that operation of the package should not be affected by the loss of one engine or by switching inverters.

- 1-15. Photographic performance of the package depends upon platform attitude. Platform attitude should be level in pitch and roll and

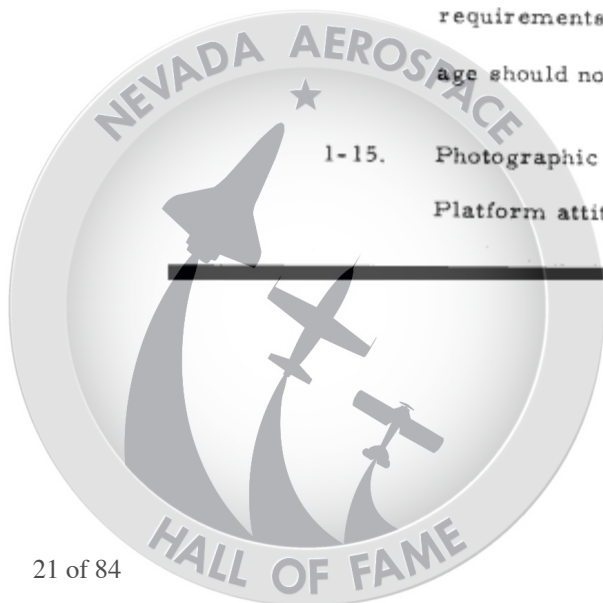

ADDENDUM

A - 12 FLIGHT HANDBOOK

parallel in azimuth with the vehicle line of flight. The package is installed in the vehicle such that in the caged condition the platform is level in pitch and roll when the vehicle is at nominal cruise attitude of $+7^{\circ}$ in pitch and 0° in roll. See Figure 1-7.

1-16. The package will uncage in the operate mode only when the platform is coarse level -- within $\pm 2^{\circ}$ of true vertical. The vehicle must be within $\pm 2^{\circ}$ in pitch and roll of its nominal cruise attitude as shown in Figure 1-8.

1-17. In the uncaged condition the package will stabilize with respect to rate and verticality and will automatically align itself with respect to the vehicle flight path. The package will remain uncaged and stabilize within the following vehicle attitude limits :

Pitch	$7^{\circ} \pm 3 \frac{1}{3}^{\circ}$
Roll	$0^{\circ} \pm 3^{\circ}$
Yaw	$0^{\circ} \pm 2^{\circ}$

The package frame physically prevents the stabilized platform from exceeding the above limits. When any limit has been reached, a corresponding clearance switch will close and cage the platform.



ADDENDUM

A-12 FLIGHT HANDBOOK

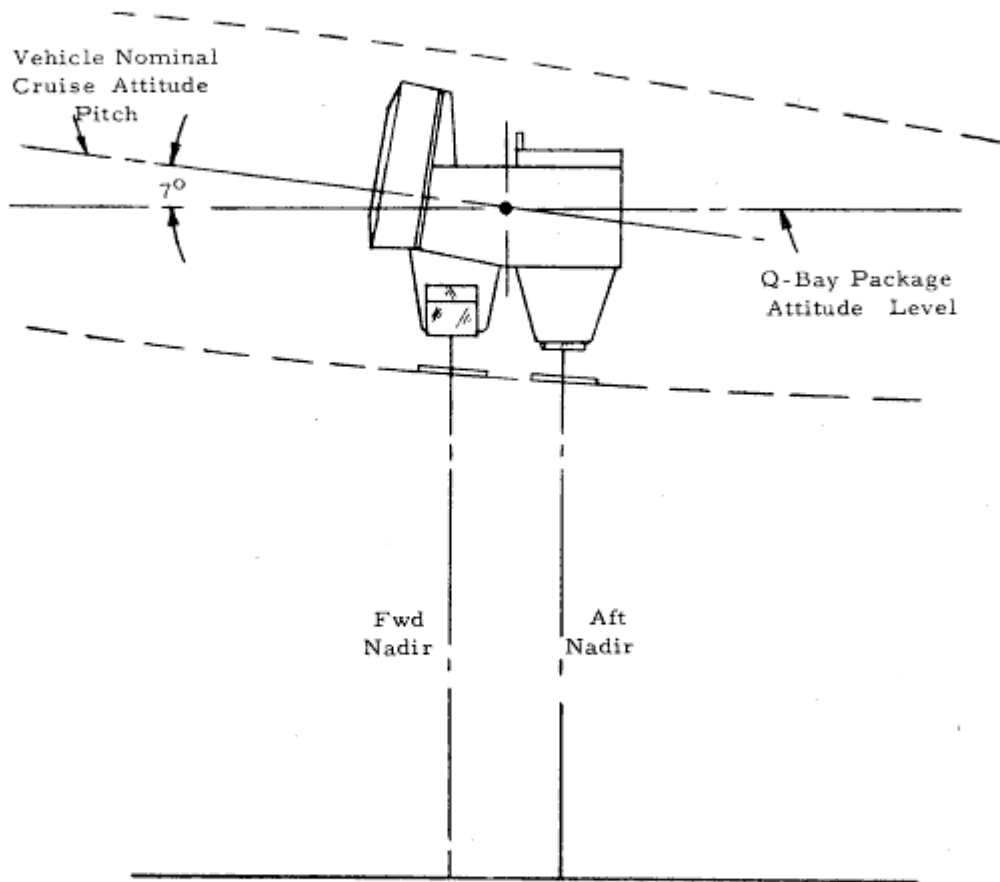
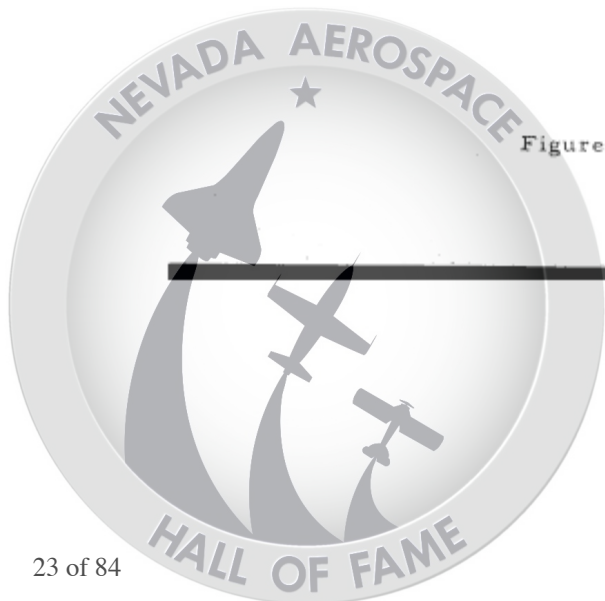

Figure 1-7. Q-Bay Package Type I and Vehicle Relationships, Caged Condition



ADDENDUM

A-12 FLIGHT HANDBOOK

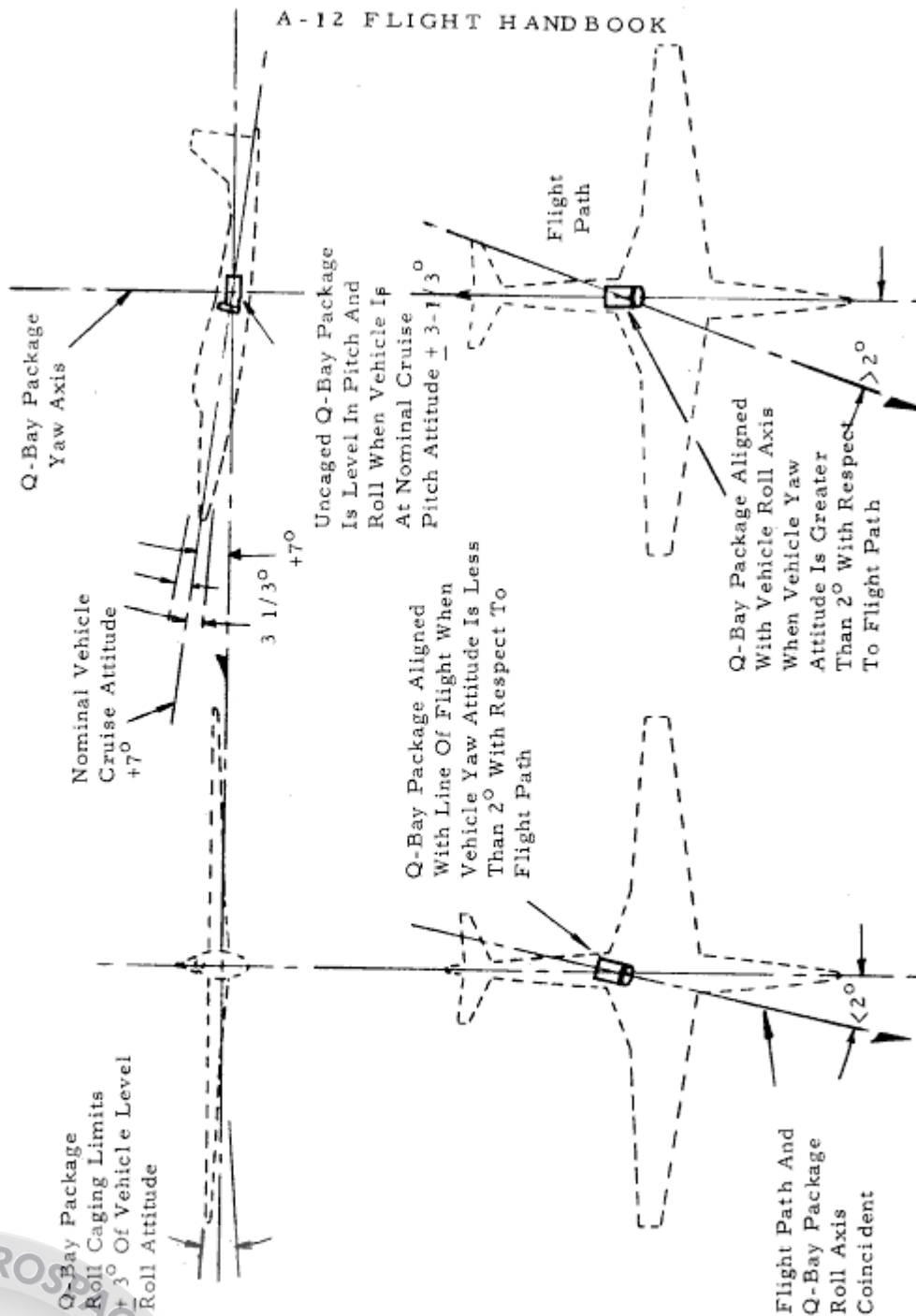

Figure 1-8. Vehicle And Type I Attitude Relationships, Uncaged Condition



ADDENDUM

A - 12 FLIGHT HANDBOOK

- 1-18. In the caged condition the package is fixed with respect to the vehicle and is level in pitch and roll only when the vehicle attitude is :

Pitch	+ 7°
Roll	0°
Yaw	---

- 1-19. During a normal mission-run, the package is expected to cage and uncage possibly more than once due to vehicle attitude perturbations that exceed the platform caging limits. Uncaging is accomplished by a compressed helium supply of limited quantity. When the supply is exhausted, the platform will not uncage.
- 1-20. It is possible for the platform to experience at least 25 uncaging and caging cycles during one mission. Should the number of caging cycles exceed 25 at any time during the mission, then the possibility exists that the platform will remain caged for the remainder of the mission.
- 1-21. Type I - Operation.
- 1-22. The Type I package does not operate continuously throughout the entire mission. The package may be operated continuously for



ADDENDUM

A-12 FLIGHT HANDBOOK

a portion of the mission, or it may be operated intermittently for an extended portion of the mission. The flight plan will normally indicate the exact operating procedure.

- 1-23. The package will operate properly and should be operated when required either in a caged condition or an uncaged condition. Best photographic performance, however, can be expected in the uncaged, self-stabilized mode. When the package is being operated in the caged condition, vehicle attitude rates directly affect the photographic performance. Vehicle flight should be kept smooth and changes in vehicle attitude should be accomplished as smoothly as possible. This will minimize photographic degradation.
- 1-24. Two typical Type 1 mission profiles are shown in Figure 1-9. Mission 1 shows continuous operation of the package for a segment of the entire mission. Mission 2 shows intermittent operation of the package for arbitrary portions of the mission. In practice, the package will always be placed in the standby 1 mode at some time during the final pre-flight check and shall remain there until standby 2 switch is selected. Specific flight instructions will state the exact sequence of operation of the status switch for the standby 2 and operate modes, as shown in Figure 1-9.

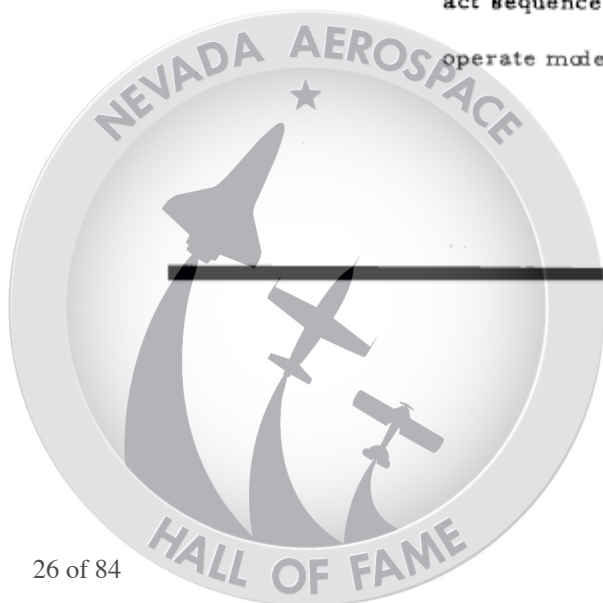

ADDENDUM
A-12 FLIGHT HANDBOOK

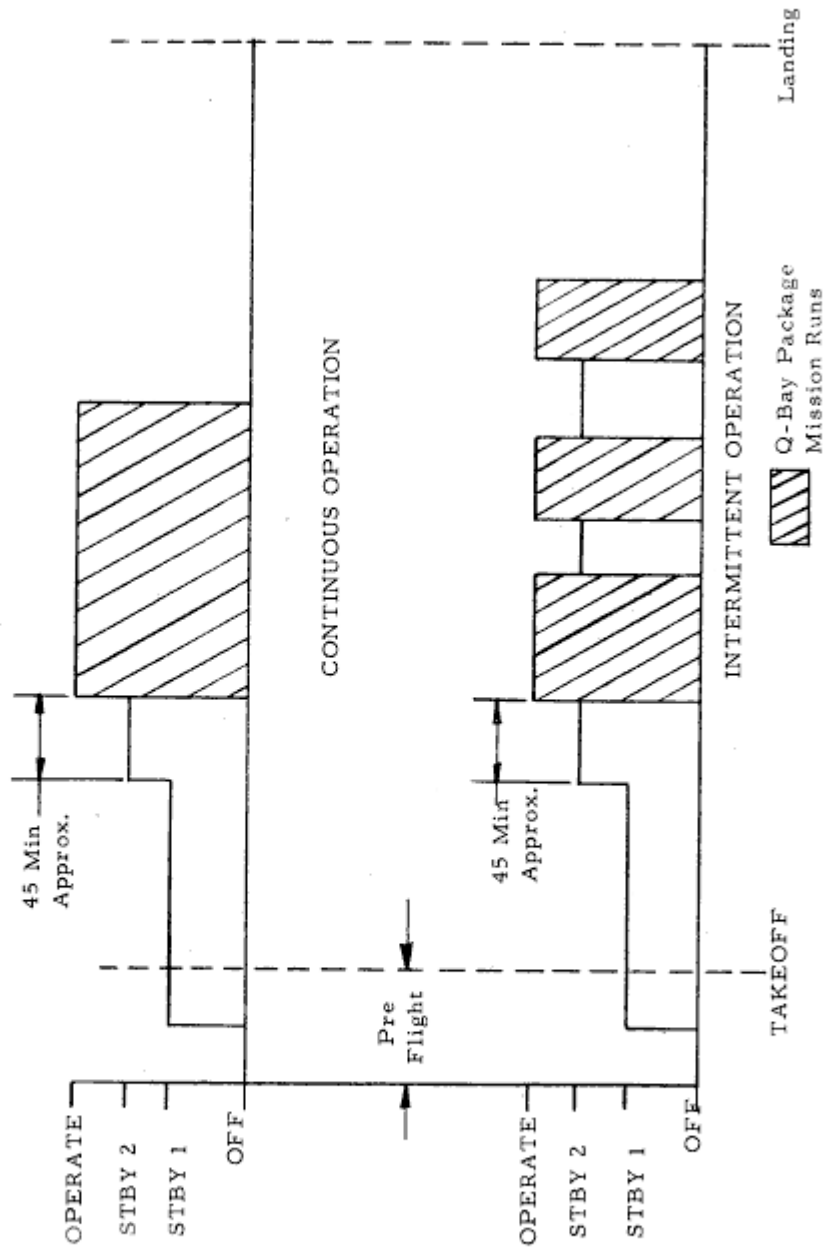

Figure 1-9. Typical Type I Mission Profiles



ADDENDUM
A-12 FLIGHT HANDBOOK

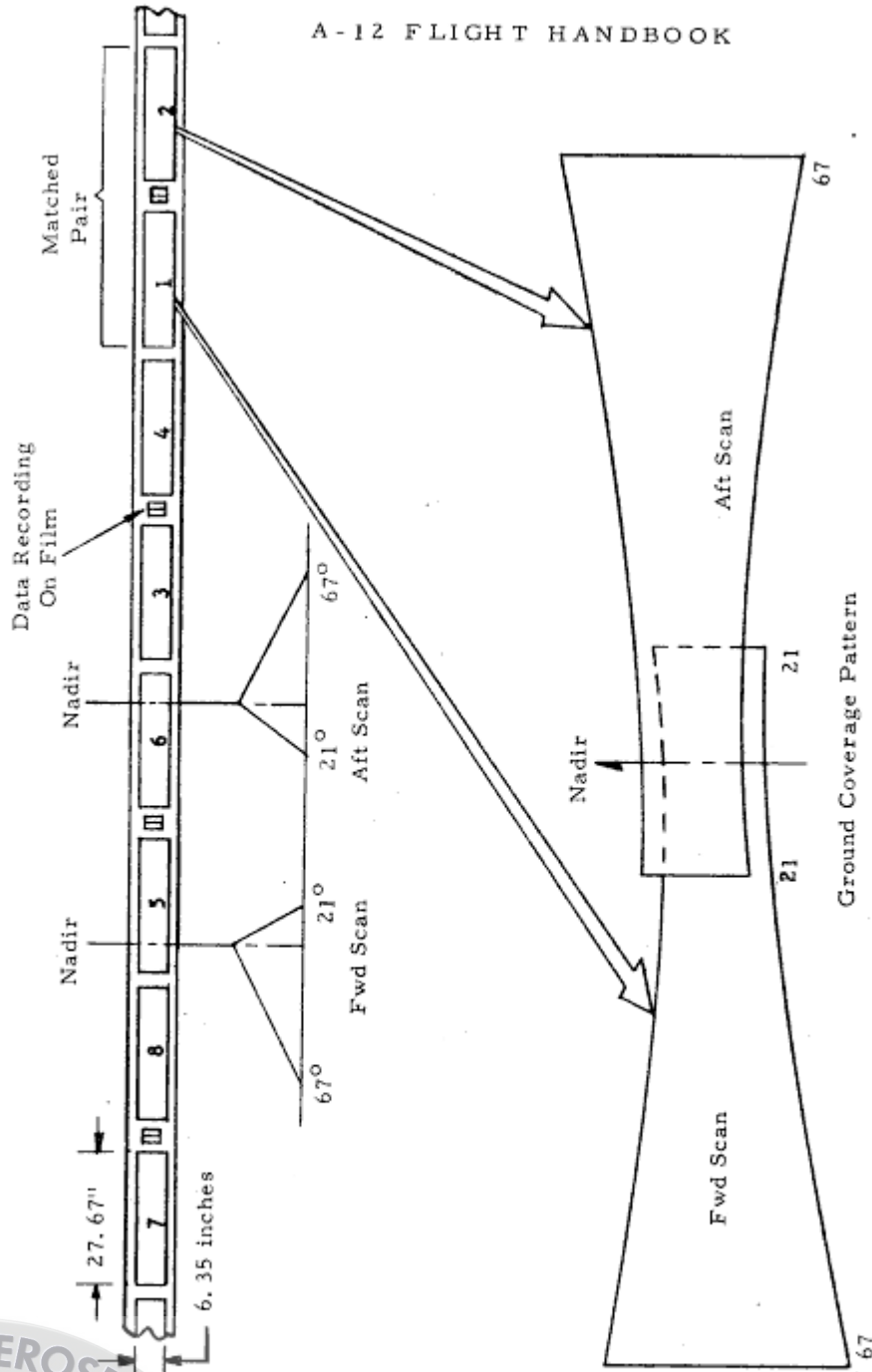

Figure 1-10. Type I Package Frame Format Relationship To Ground Coverage Pattern



ADDENDUM
A-12 FLIGHT HANDBOOK

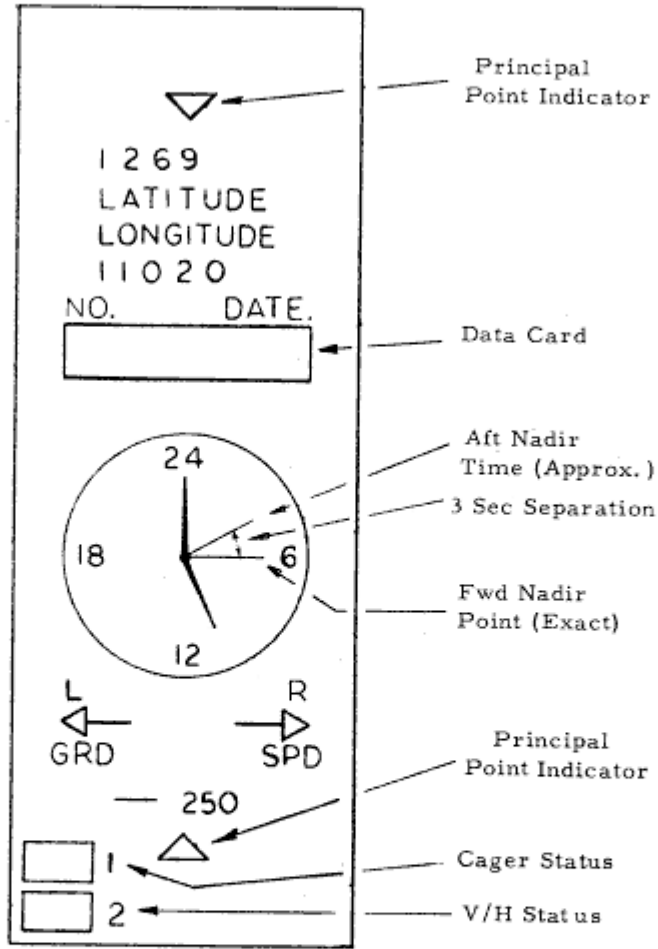

Figure 1-11. Data Recording On Film



ADDENDUM

A - 12 FLIGHT HANDBOOK

- 2-1. Type II - General.
- 2-2. The Type II equipment bay package is an aerial panoramic camera system with the mission of obtaining photographs of the earth from an airborne vehicle. The camera system photographs the earth transverse to the vehicle line of flight. Two camera within a single package (stable platform) are employed to accomplish the photography -- a forward system and an aft system.
- 2-3. Photographic coverage of the Type II system is represented in Figure 2-1. The forward camera scans the earth from 63° to the left of nadir to 30° to the right of nadir. The aft camera scans the earth from 30° to the left of nadir to 63° from the right of nadir. Each mission can provide 3670 nautical miles of flight line coverage on 2828 frames and 50 to 63 miles (or 126°) total transverse coverage. The scan overlap provides full stereo viewing of mission results for all points on each frame format. In addition to normal stereo, convergent stereo is available within the scan overlap of 30° each side of the vertical centerline. See Figure 2-2.



ADDENDUM
A-12 FLIGHT HANDBOOK

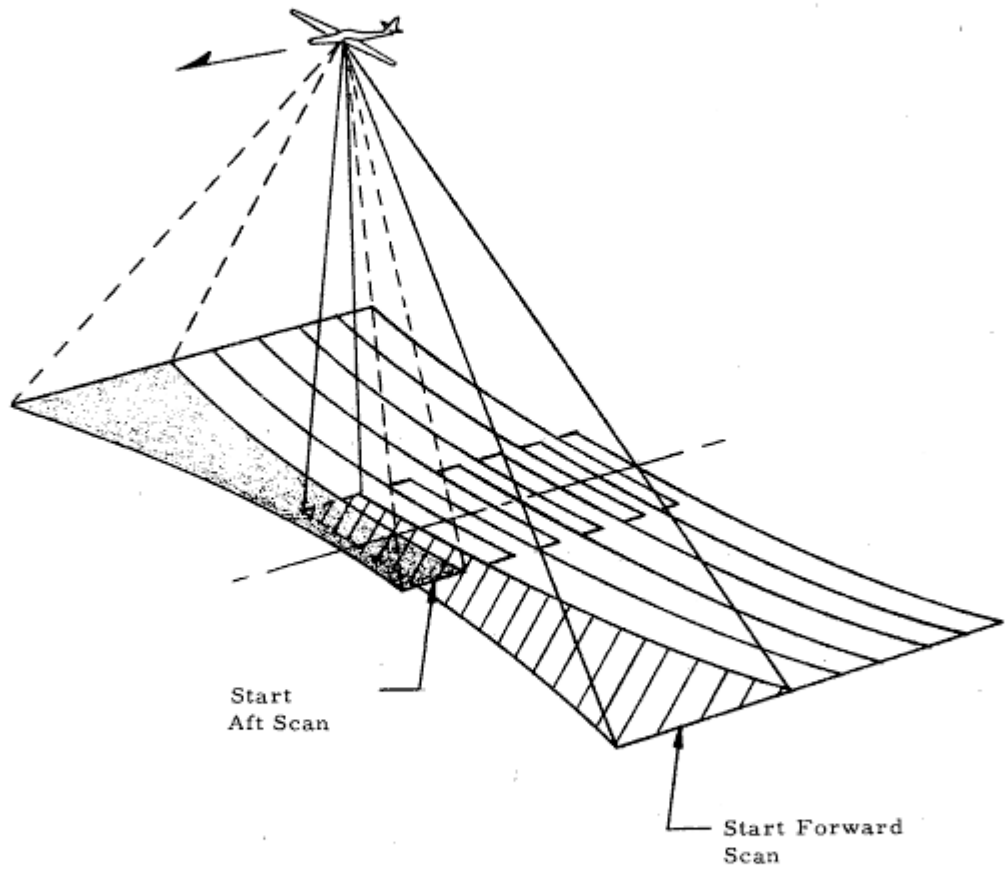
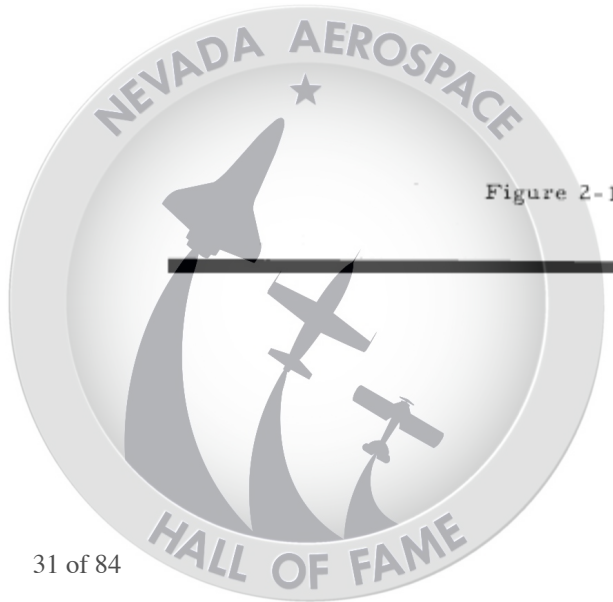

Figure 2-1. Aerial Panoramic Photography, Type II



ADDENDUM

A-12 FLIGHT HANDBOOK

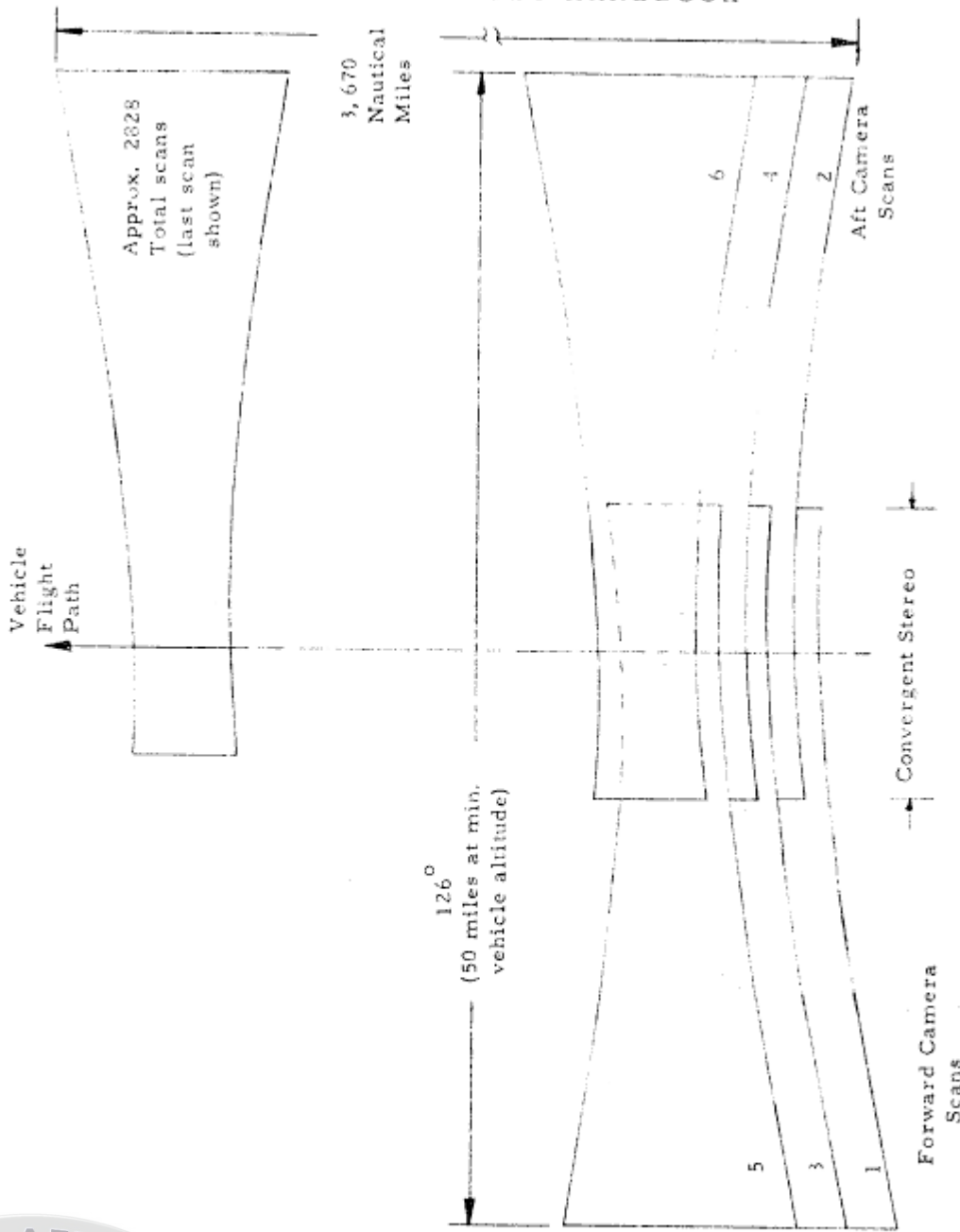

Figure 2-2. Ground Coverage Format, Straight And Level Flight, Type II



ADDENDUM

A-12 FLIGHT HANDBOOK

- 2-4. The package consists of two major assemblies -- a stable platform and a supporting frame assembly. See Figure 2-3. The stable platform consists of 2 identical cameras and the stabilization system. The entire assembly is installed in the Q-Bay at three isolation shock mounts. The majority of the supporting electronic equipment associated with the Type II package is installed within framework on the upper Q-Bay hatch.
- 2-5. The platform is normally in either one of two conditions -- caged or uncaged. In the caged condition, the platform is locked to the frame and therefore fixed with respect to the vehicle (except for 3/8" isolator freedom). In the uncaged condition, the platform is freely suspended from the gimbal support, and is allowed to stabilize with respect to rate and verticality. The caging system provides an effective means to quickly and automatically change the condition of the platform.
- 2-6. The control panel for the Type II package is shown in Figure 2-4. The control panel is located on the left cockpit console, and occupies an area approximately 6 inches by 3 inches.



ADDENDUM
A-12 FLIGHT HANDBOOK

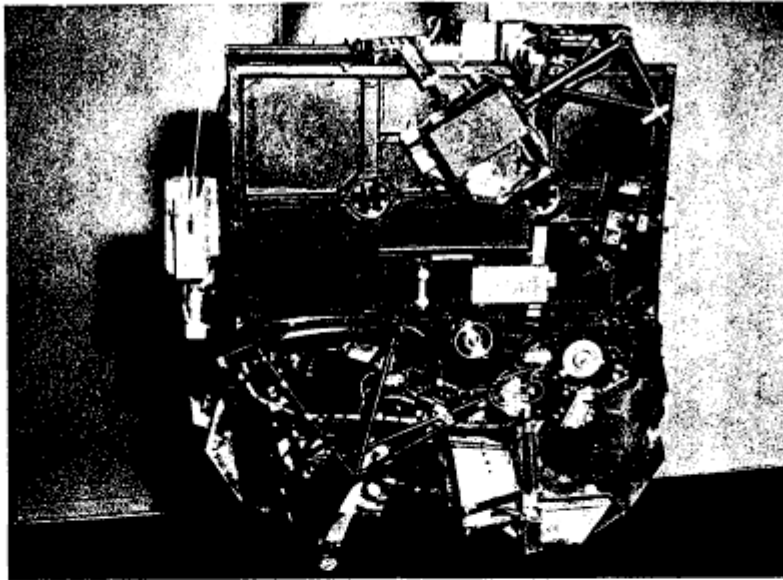

LOOKING AFT

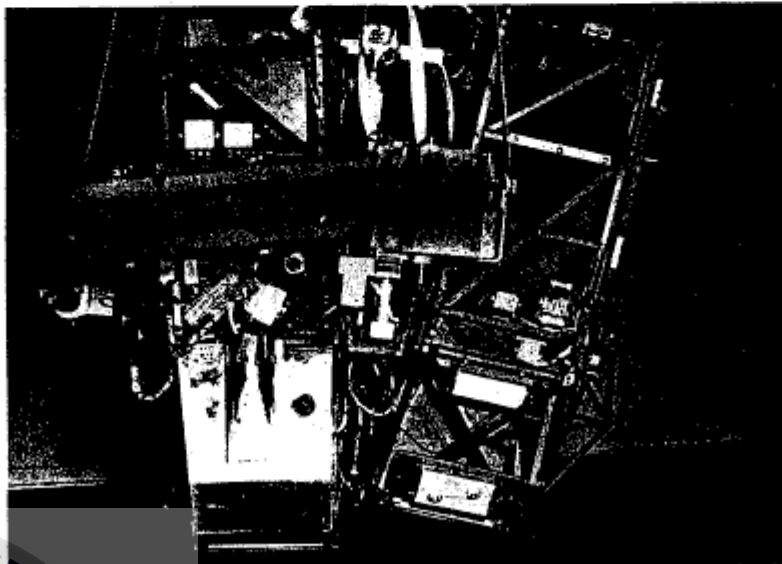

RIGHT SIDE

Figure 2-3. Q-Bay Package Type II Physical Description

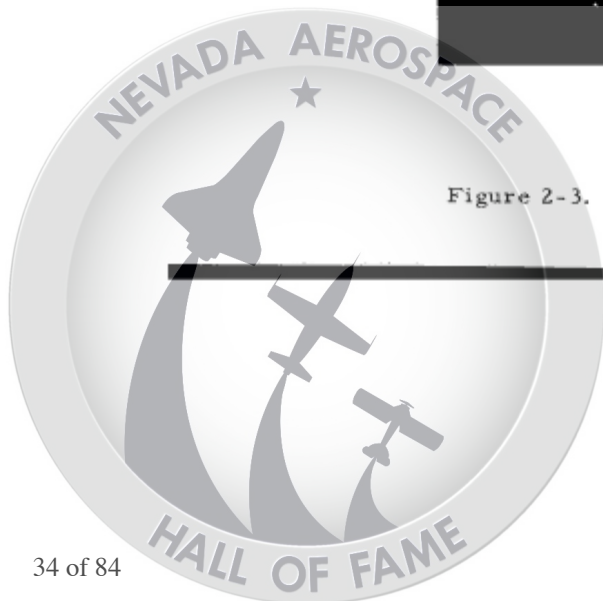

ADDENDUM
A-12 FLIGHT HANDBOOK

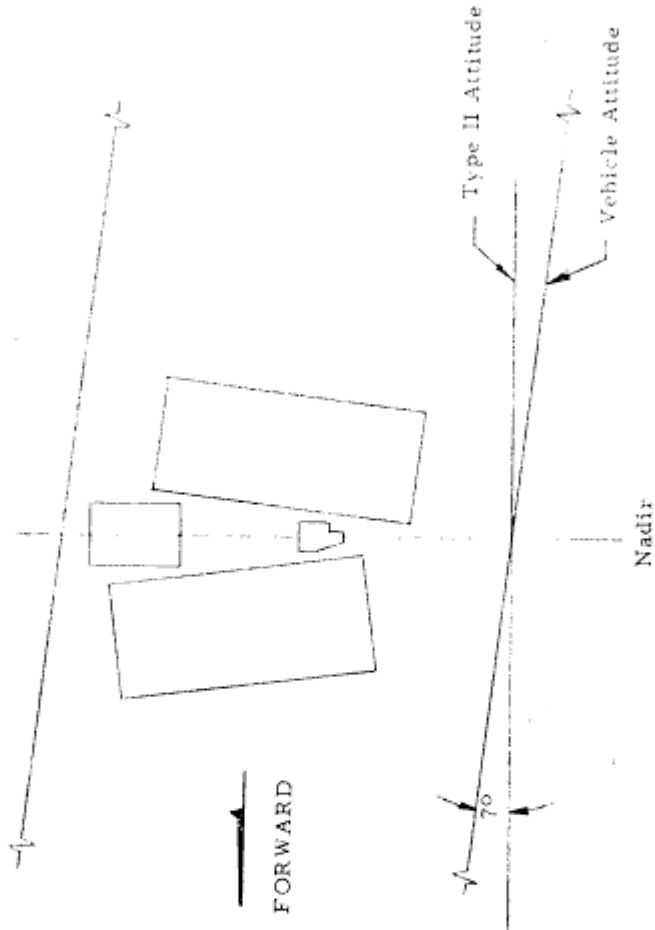
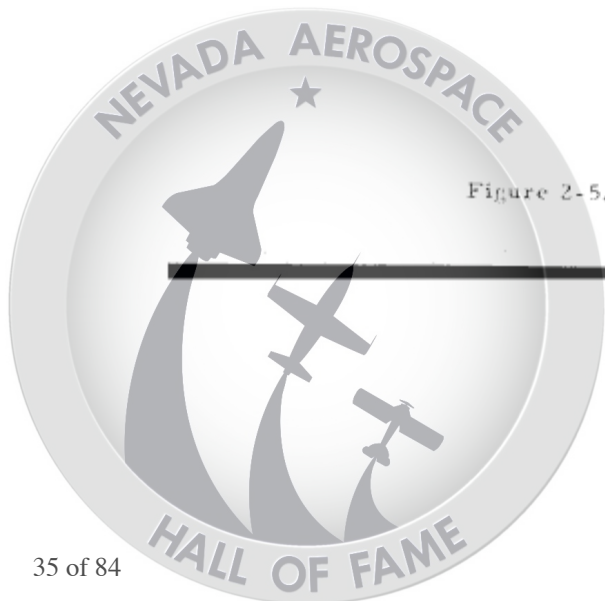

Figure 2-5. Q-Bay Package Type II and Vehicle Attitude Relationships, Caged Condition



ADDENDUM

A - 12 FLIGHT HANDBOOK

- 2-13. During a normal mission-run, the package is expected to cage and uncage possibly more than once due to vehicle attitude perturbations that exceed the platform caging limits.
- 2-14. Type II - Operation.
- 2-15. The Type II package does not operate continuously throughout the entire mission. The package may be operated continuously for a portion of the mission, or it may be operated intermittently for an extended portion of the mission. The flight plan will normally indicate the exact operating procedure.
- 2-16. The package will operate properly and should be operated when required either in a caged condition or an uncaged condition. Best photographic performance, however, can be expected in the uncaged, self-stabilized mode. When the package is being operated in the caged condition, vehicle attitude rates directly affect the photographic performance. Vehicle flight should be kept as smooth as possible and changes in vehicle attitude should be accomplished as smoothly as possible. This will minimize photographic degradation.



ADDENDUM

A-12 FLIGHT HANDBOOK

- 2-17. Two typical Type II mission profiles are shown in Figure 2-6. Mission 1 shows continuous operation of the package for a segment of the entire mission. Mission 2 shows intermittent operation of the package for arbitrary portions of the mission. During initial ascent after refuel, turn HEATER switch to ON position. Specific flight instructions will determine when the RECORD switch is to be turned to the ON position as shown in Figure 2-6.
- 2-18. The Q-BAY EQUIPMENT OUT indicator (red) on the warning light panel, center console, will light in the event of package failure. Should the failure light illuminate, turn RECORD switch to OFF position. Wait approximately 1 minute, and return RECORD switch to ON. If failure light comes on again, turn RECORD and HEATER switches to OFF.
- 2-19. Ideally, a mission-run will be flown in a great circle route; the Type II package will operate in an uncaged condition all of the way; the mission flight path will be exactly as expected; the photographic results will include the area of earth desired.



ADDENDUM
A-12 FLIGHT HANDBOOK

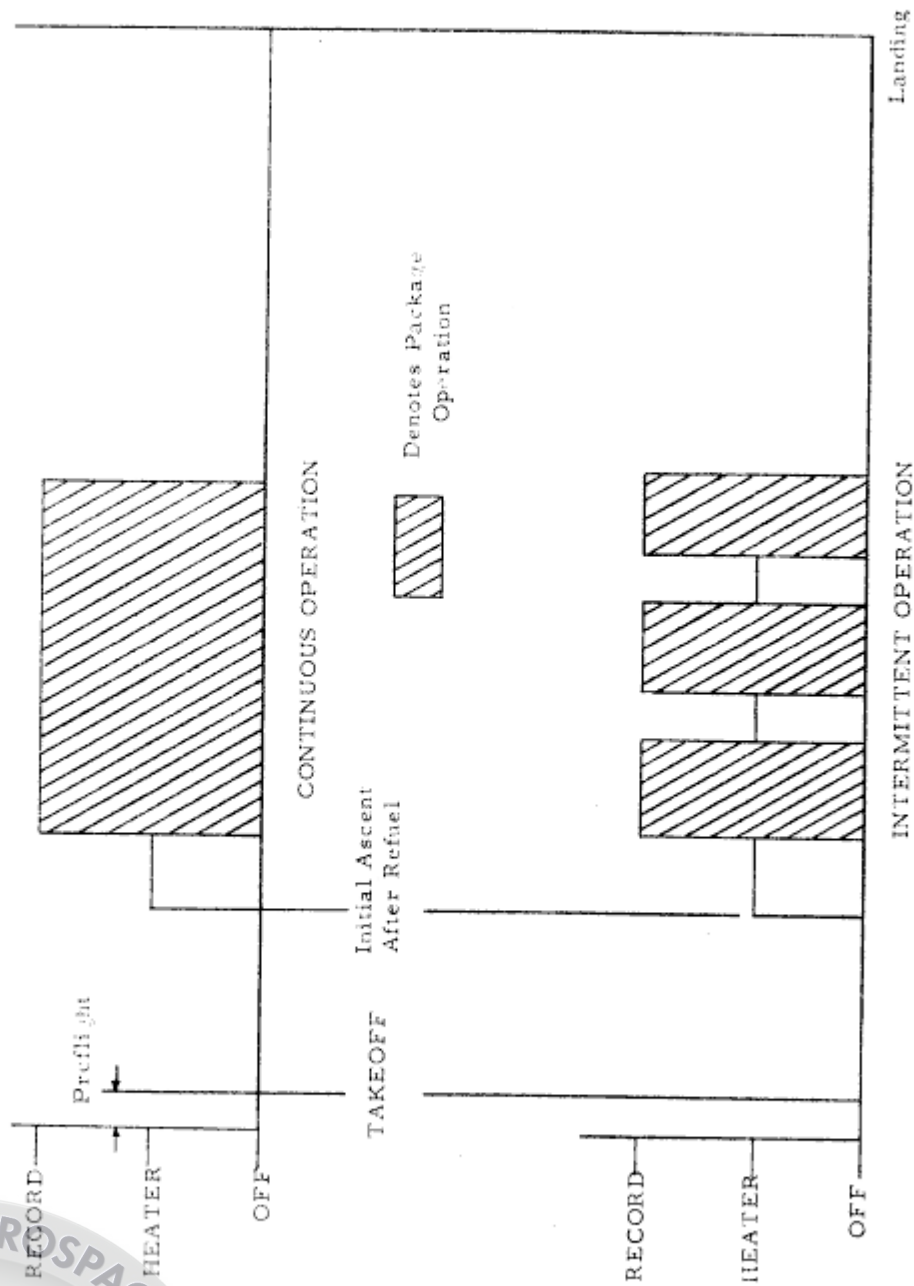

Figure 2-6. Typical Type II Mission Profiles



ADDENDUM

A-12 FLIGHT HANDBOOK

- 2-20. The earth below the vehicle and extending to 25 to 31 miles on either side is being photographed when the vehicle is at minimum to maximum altitude. When the flight path is not as expected, it is better in terms of photographic performance to continue without flight path correction -- a "direct hit" not being important as far as obtaining the necessary photographic coverage.
- 2-21. Caged operation, however, requires the utmost attention. Vehicle attitude rates must be kept low; the vehicle must fly as smoothly as possible to minimize photographic degradation.
- 2-22. If photography with the aid of the periscope wide field is desired, system operation, in most cases, will be programmed according to time and earth coordinates. However, circumstances could be that the operator is responsible for determining photographic coverage through use of the periscope.
- 2-23. If an object to be photographed appears on the periscope, turn RECORD switch to RECORD position. Photography will take place after a one minute delay period.



ADDENDUM

A-12 FLIGHT HANDBOOK

- 2-24. Results of the Type II camera systems are panoramic photographs as shown in Figure 2-7. Photographs from the forward camera and corresponding photographs from the aft camera are aligned as shown also in Figure 2-7, along with the associated data information recorded alongside of each frame. Approximately 1414 photographs with recorded data can be expected from a full film supply of 4200 feet from each camera. Film width is 7.95 inches. Individual frame dimensions are 7.5 inches by 34.23 inches.
- 2-25. Latitude, longitude, timing track, principal point, mission number, date, caging signal, aircraft attitude and camera unit numbers are recorded for each frame in a predetermined code form.



ADDENDUM

A-12 FLIGHT HANDBOOK

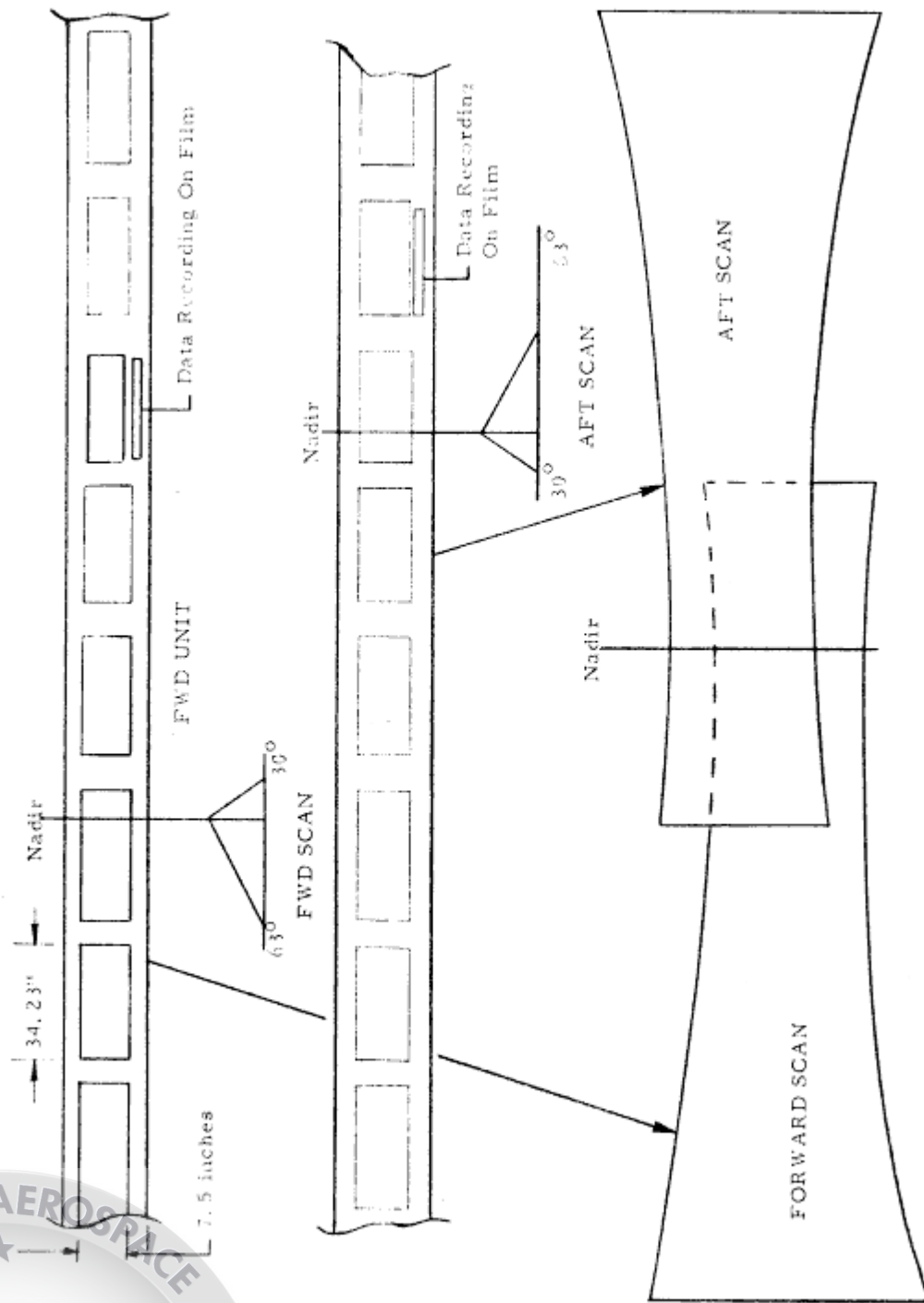
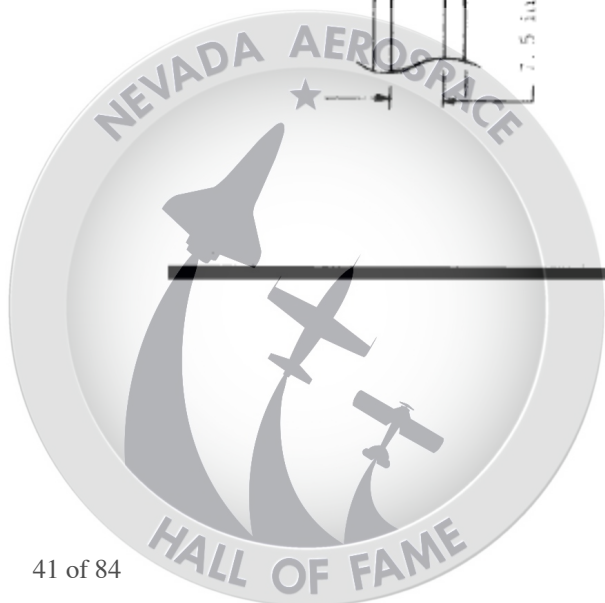

Figure 2-7. Type II Package Format Relationship To Ground Coverage Pattern



ADDENDUM

A - 12 FLIGHT HANDBOOK

- 3-1. Type III - General.
- 3-2. The Type III equipment bay package is an aerial camera system with the mission of obtaining photographs of the earth from an airborne vehicle. The camera system photographs the earth transverse to the vehicle line of flight. A single camera is utilized that sweeps laterally to take photographs in five basic positions -- two right oblique, one vertical and two left oblique.
- 3-3. Photographic coverage of the camera system is represented in Figure 3-1. There are two distinct modes of operation with the Type III package. Mode 1 sweeps continuously through the five basic positions while mode 2 photographs continuously at the same rate, however, in a vertical position only. Mode 1 covers approximately 60° each side of nadir. Mode 2 covers 14° each side of nadir. Each mission can provide 2850 nautical miles flight line coverage on 3900 frames and 51 to 55 nautical miles (or approximately 120°) of total transverse coverage. The scan overlap provides stereo viewing approximately 53° each side of nadir or an approximate total of 106° . See Figure 3-1.



ADDENDUM
A-12 FLIGHT HANDBOOK

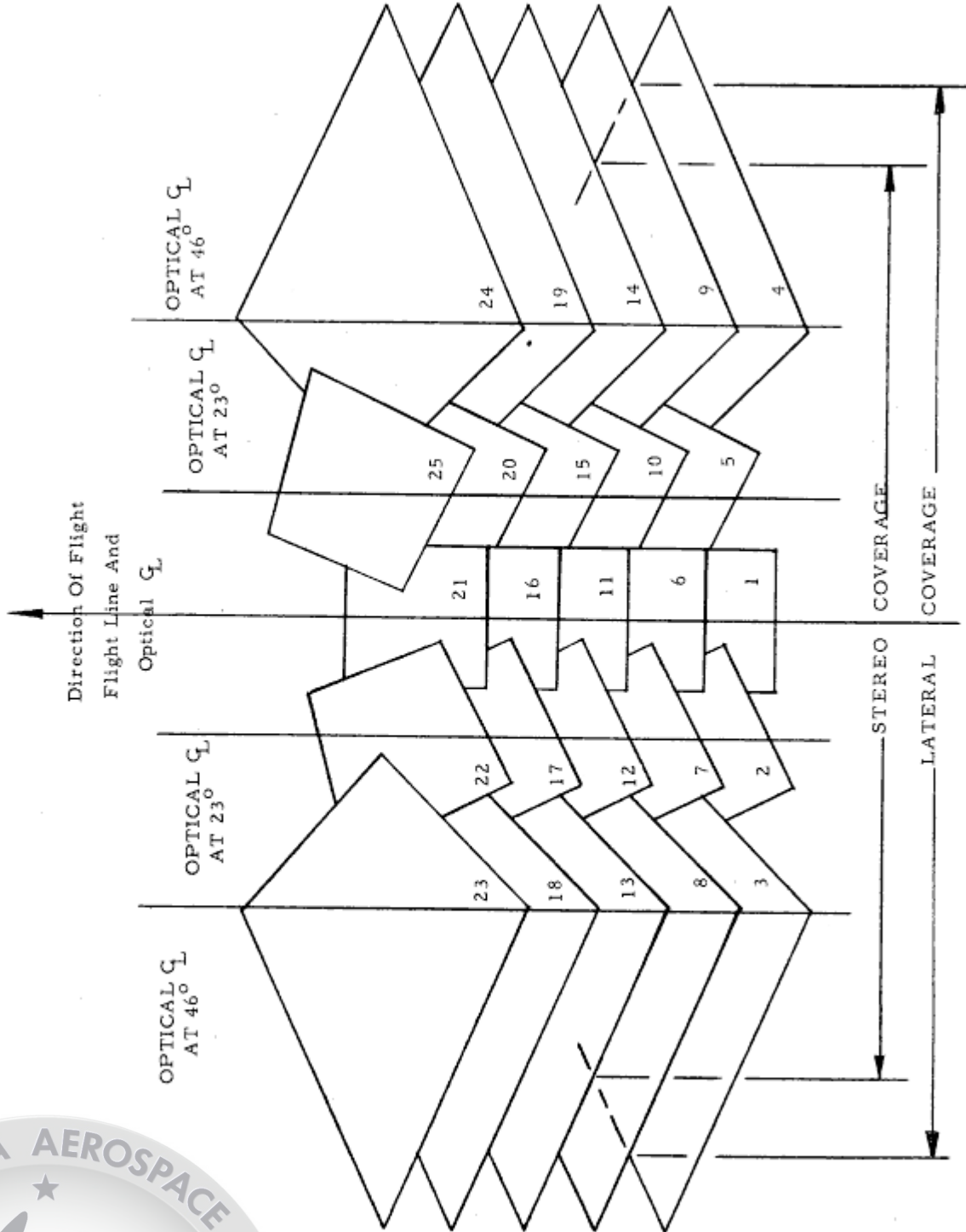
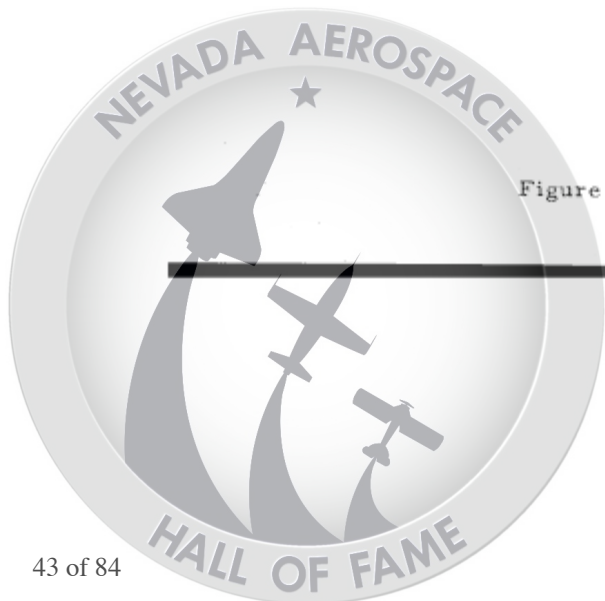

Figure 3-1. Ground Coverage Format, Straight and Level Flight, Type III



ADDENDUM

A - 12 FLIGHT HANDBOOK

- 3-4. The Type III package consists of a single assembly which mounts directly to the vehicle through vibration isolators. See Figure 3-2.
- 3-5. The control panel for the Type III package is shown in Figure 3-3. The control panel is located on the left cockpit console, and occupies an area approximately 6 inches by 3 inches.
- 3-6. The two position POWER switch when turned to the ON position provides power to the camera, but will not start operation until SCAN (mode 1) or VERTICAL (mode 2) position is selected on OPERATE switch. The STANDBY position of the OPERATE switch is to be selected when camera operation is not desired.
- 3-7. The package utilizes 28 volt D. C. electrical power from the Essential D. C. Bus.
- 3-8. The package is installed in the vehicle such that it is level when the vehicle is in a nominal cruise attitude of $+7^{\circ}$ in pitch.



ADDENDUM

A-12 FLIGHT HANDBOOK

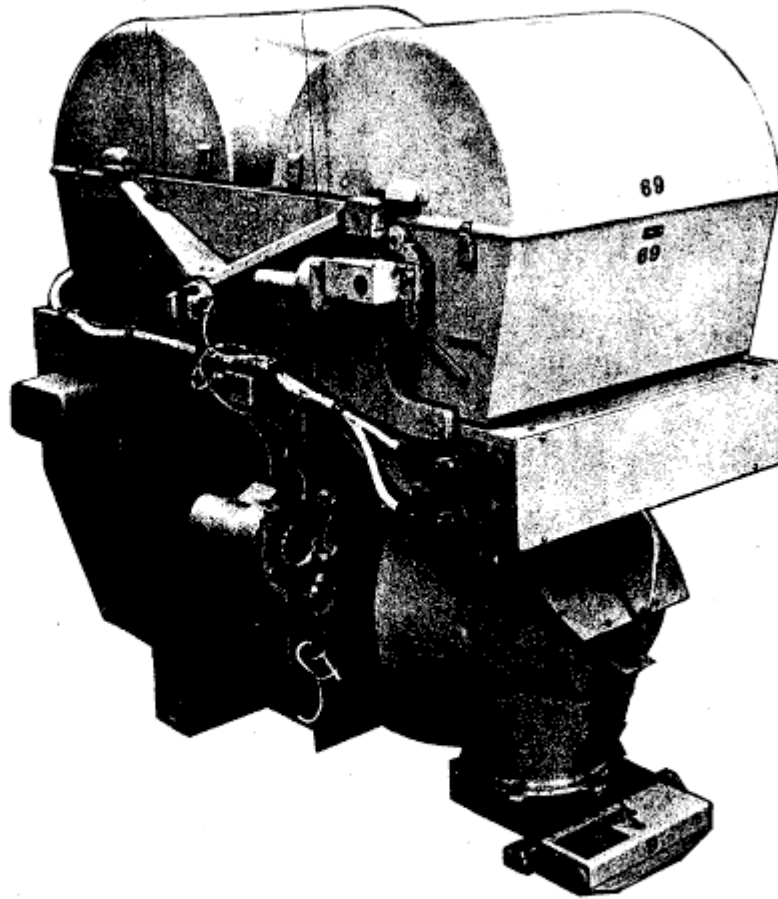

Figure 3-2. Q-Bay Package Type III Physical Description



ADDENDUM
A-12 FLIGHT HANDBOOK

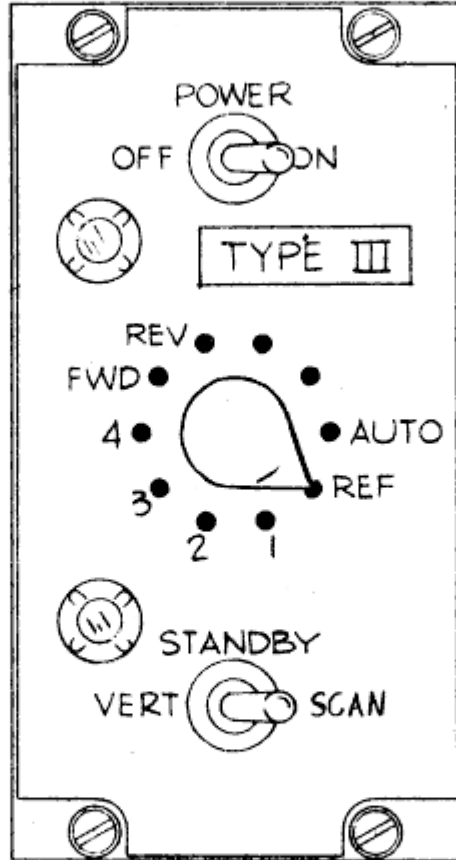
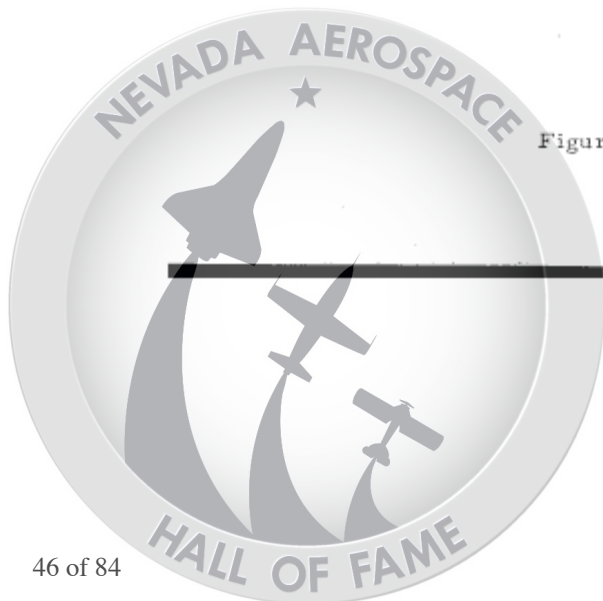

Figure 3-3. Type III Control Panel



ADDENDUM

A-12 FLIGHT HANDBOOK

- 3-9. Type III - Operation.
- 3-10. The Type III package does not operate continuously throughout the entire mission. The package may be operated continuously for a portion of the mission, or it may be operated intermittently for an extended portion of the mission. The flight plan will normally indicate the exact operating procedure.
- 3-11. Vehicle flight should be kept smooth and changes in vehicle attitude should be accomplished as smoothly as possible. This will minimize photographic degradation.
- 3-12. Two typical Type III mission profiles are shown in Figure 3-4. Mission 1 shows continuous operation of the package for a segment of the entire mission. Mission 2 shows intermittent operation of the package for arbitrary portions of the mission. In practice, the package will always be placed in the STANDBY position at some point during the final pre-flight check and will remain there until the start of the mission.
- 3-13. The Q-BAY EQUIPMENT FAILURE indicator (red) on the warning panel, center console, will light in the event of package failure.



ADDENDUM

A-12 FLIGHT HANDBOOK

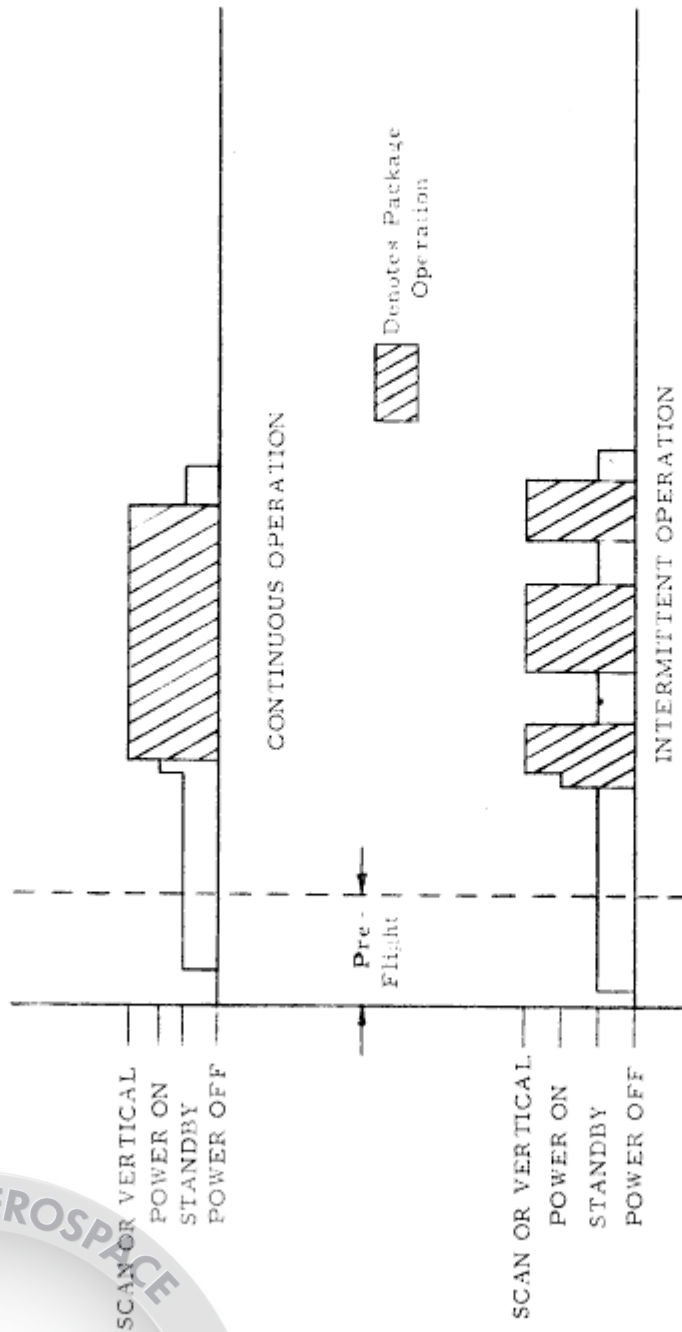

Figure 3-4. Typical Type III Mission Profile



ADDENDUM
A - 12 FLIGHT HANDBOOK

- 3-14. Should the Type III package fail during normal operation, the following procedure is recommended :
- a. Place the OPERATE switch to STANDBY. The Q-BAY EQUIPMENT FAILURE light on the warning panel will go out.
 - b. Wait 15 seconds.
 - c. Place OPERATE switch to VERTICAL or SCAN positions. If failure light comes on again, turn OPERATE switch to STANDBY, wait 15 seconds minimum, and then turn POWER switch to OFF.
- 3-15. Ideally, a mission-run will be flown in a great circle route; the Type III package will operate satisfactorily all the way; the mission flight path will be exactly as expected; the photographic results will include the area of the earth desired.
- 3-16. The earth below the vehicle and extending 25 to 28 nautical miles on either side is being photographed when the vehicle is at minimum to maximum altitudes. When the flight path is not as expected, it is better in terms of photographic performance to continue without flight path correction -- a "direct hit" not being important as far as obtaining the necessary photographic coverage.



ADDENDUM

A-12 FLIGHT HANDBOOK

- 3-17. If photography with the aid of the periscope wide field is desired, system operation, in most cases, will be programmed according to time and earth coordinates. However, circumstances could be that the operator is responsible for determining photographic coverage through the use of the periscope.
- 3-18. If an object to be photographed appears on the periscope, turn OPERATE switch to SCAN or VERTICAL positions and photography starts immediately.
- 3-19. Results of the Type III camera are sets of photographs in the format shown in Figure 3-1. Each frame contains recorded data and identification of frame position, i. e., one through five. Approximately 3900 photographs with recorded data can be expected from a full film supply of 6000 feet. Individual frame size is 18 inches by 18 inches.
- 3-20. Mission number, time, date and frame position are recorded for each frame.



ENC 1 TO
OXC-5503
COPY 1 OF 1

1 - NRO-MK
2 NPIC

August 20, 1963

File OY
LOCKHEED A-12

Dear Jack :

The enclosed handbook is our present version of the instructions to pilots for use of our photographic equipment. I would appreciate your looking at it critically with regard to additions or deletions which we should make.

Because of the security nature of the contents of this Addendum, it will not be included as a regular part of the A12 Flight Handbook. It will be made available to operations and pilots for use in a secure fashion.

Please advise me as to who you believe should have copies of this Addendum and how many.

Best regards,

[Redacted signature box]

kld





OXC-5503
COPY OF

ADDENDUM
A-12 FLIGHT HANDBOOK
PHOTOGRAPHIC EQUIPMENT

Issued: February, 1963
Revised: August, 1963



SECURITY INFORMATION

Specific Instructions For Safeguarding This Information :

1. This document contains information affecting the national defense of the United States within the meaning of the Espionage Laws Title 18, USC Section 793 and 794. The transmission or the revelation of its contents in any manner to unauthorized persons is prohibited by law.

The nature of this document is such that dissemination and handling will be carried out with strict adherence to the following policies :

- a. Distribution will be controlled on a strict, officially established "need-to-know" basis.
 - b. Strict accountability of each document will be maintained.
 - c. This document will be controlled in such a fashion to prevent its loss, destruction, or falling into the hands of unauthorized persons.
2. In the event this document is lost or is subject to unauthorized disclosure or other possible subjection to compromise of classified information, such fact will be promptly reported to the authority responsible for the custody of the material for appropriate action.



TABLE OF CONTENTS

Paragraph	Title	Page
1-2	General Information	1
1-4	Type I - General	1
1-21	Type I - Operation	19
2-1	Type II - General	28
2-14	Type II - Operation	37
3-1	Type III - General	43
3-9	Type III - Operation	48



LIST OF ILLUSTRATIONS

Figure	Title	Page
1-1.	Camera Configuration Characteristics	2
1-2.	Aerial Panoramic Photography, Type I	4
1-3.	Ground Coverage Format, Straight and Level Flight, Type I	5
1-4.	Q-Bay Package Type I, Physical Description	6
1-5.	Q-Bay Package Type I, System Dimensions	7
1-6.	Type I Control Panel	10
1-7.	Q-Bay Type I and Article Attitude Relationships, Caged Condition	17
1-8.	Vehicle and Type I Attitude Relationships, Uncaged Condition	18
1-9.	Typical Type I Mission Profile	21
1-10.	Type I Package Frame Format Relationship To Ground Coverage Pattern	26
1-11.	Data Recording on Film	27
2-1.	Aerial Panoramic Photography, Type II	29
2-2.	Ground Coverage Format, Straight and Level Flight, Type II	30
2-3.	Q-Bay Package Type II Physical Description	32



LIST OF ILLUSTRATIONS (cont)

Figure	Title	Page
2-4.	Type II Control Panel	33
2-5.	Q-Bay Package Type II and Vehicle Attitude Relationships, Caged Condition	36
2-6.	Typical Type II Mission Profiles	39
2-7.	Type II Package Format Relationship to Ground Coverage Pattern	42
3-1.	Ground Coverage Format, Straight and Level Flight, Type III	44
3-2.	Q-Bay Package Type III Physical Description	46
3-3.	Type III Control Panel	47
3-4.	Typical Type III Mission Profiles	49



Revised : 7-29-63

ADDENDUM

A - 12 FLIGHT HANDBOOK

1-1. PHOTOGRAPHIC EQUIPMENT.

1-2. General Information.

1-3. The primary payload of the airplane consists of various camera configurations. These different groupings are designated as Type I, Type II and Type III. Any one of these may be installed in the equipment bay aft of the cockpit, depending upon the selectivity of the operating command. The characteristics chart, Figure 1-1, provides data for each of the different configurations.

Three types of lower equipment bay hatches are provided with proper window locations and sizes for the corresponding camera configuration.

1-4. Type I - General.

1-5. The Type I equipment bay package is an aerial panoramic camera system with the mission of obtaining photographs of the earth from an airborne vehicle. The camera system photographs the earth transverse to the vehicle line of flight. Two optical systems within a single camera package (stable platform) are employed to accomplish the photography - a forward system and an aft system.



Config	Focal Length	Range-Photo Flight, N. M.	Area Coverage	Ground Resolution of NADIR	Ground Scale	Operating Time	Cycle Time	Modes of Operation
Type I	19 in.	2500 Stereo	Max. swath width 75 naut. miles	1 foot	1:4750	80 min.	4.8 sec.	134° sweep which is 67° each side of a vertical centerline
Type II	21 in.	3670 Stereo	Max. swath width 63 naut. miles	1.40 ft.	1:4300	130 min.	5.7 sec.	126° sweep which is 63° each side of a vertical centerline
Type III	36 in.	2940 Stereo	Max. swath width 55 naut. miles	1.80 ft.	1:2500	Mode 1 is 93 min.	7.0 sec.	Five position sweep, three position stereo
			Vertical photo 7.4 x 7.4 naut. miles			Mode 2 is 93 min.	7.0 sec.	Vertical only

FIGURE 1-1
CAMERA CONFIGURATION CHARACTERISTICS



ADDENDUM

A-12 FLIGHT HANDBOOK

- 1-6. Photographic coverage of the camera system is represented in Figure 1-2. The forward optical system scans the earth from 67° to the left of nadir to 21° to the right of nadir. The aft optical system scans the earth from 21° to the left of nadir to 67° from the right of nadir. Each mission can provide 2500 nautical miles of flight line coverage on 1980 frames and 60 to 75 nautical miles (or 134°) total transverse coverage. The scan overlap provides full stereo viewing of mission results for all points on each frame format. See figure 1-3.
- 1-7. The package consists of two major assemblies -- a stable platform and a supporting frame assembly. See Figures 1-4 and 1-5. The stable platform is an aircraft type structure that contains both camera systems and associated subsystems, and the stabilization system. The stabilized platform is gimbal supported at its center of gravity through a gimbal support rod that is fixed to the frame assembly. The frame assembly is installed directly in the Q-Bay at four isolation shock mounts.



ADDENDUM
A-12 FLIGHT HANDBOOK

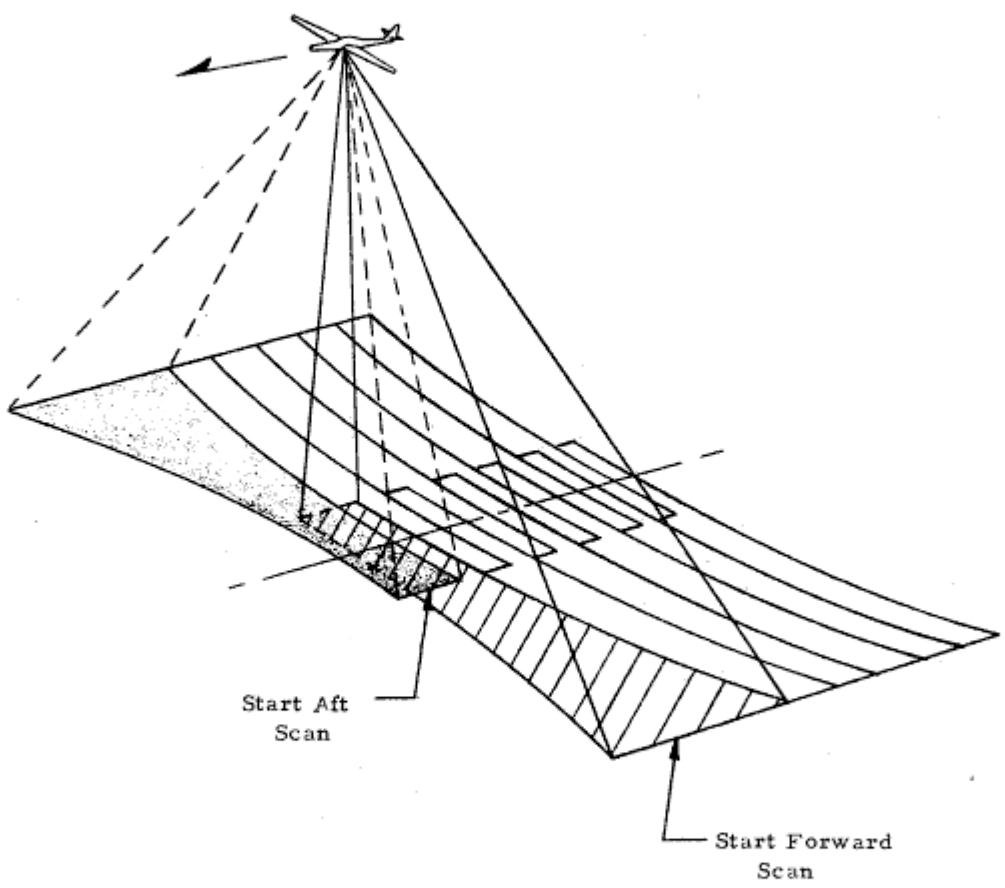

Figure 1-2. Aerial Panoramic Photography, Type I



ADDENDUM

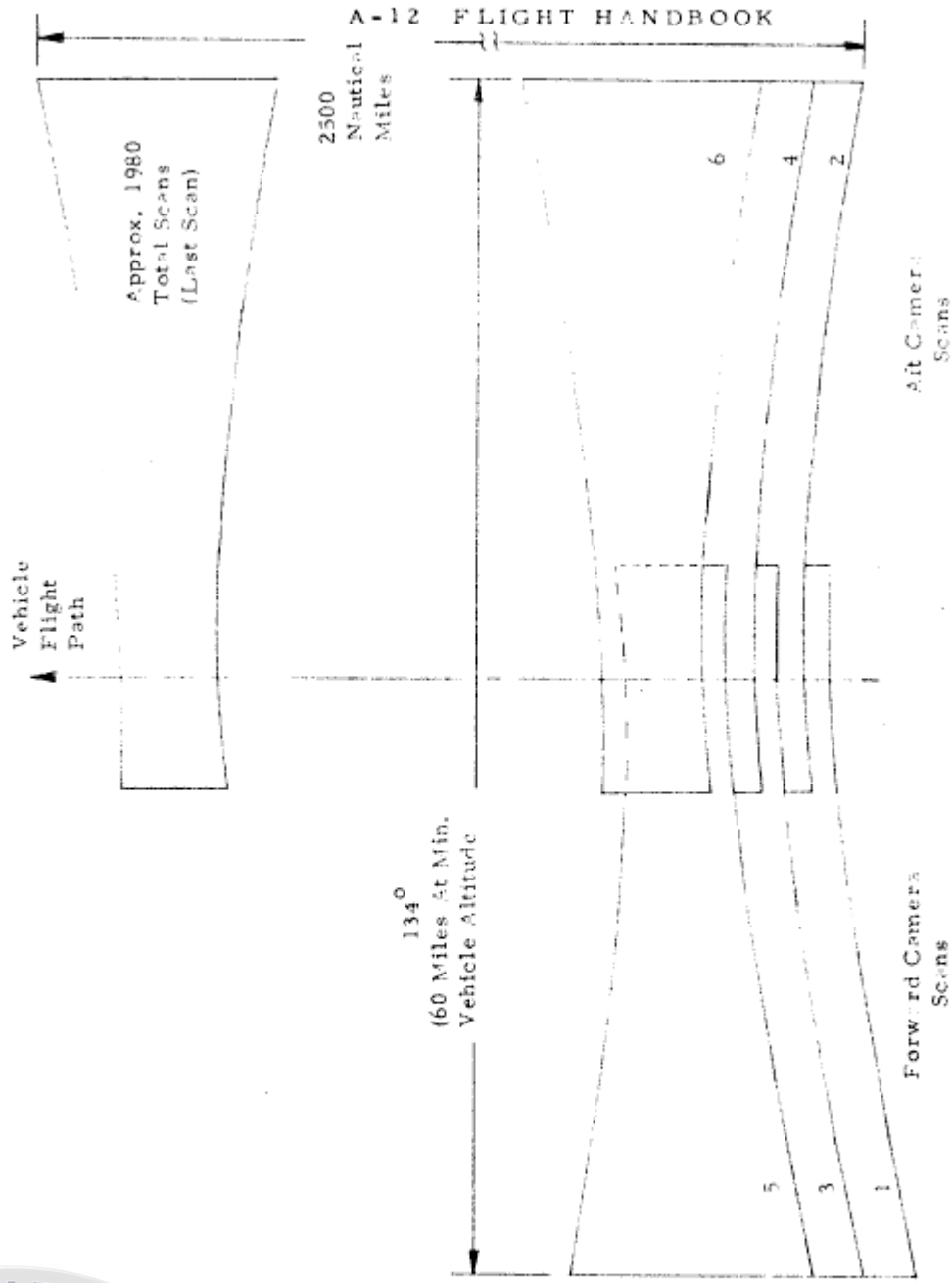

Figure 1-3. Ground Coverage Format, Straight And Level Flight, Type I



ADDENDUM
A-12 FLIGHT HANDBOOK

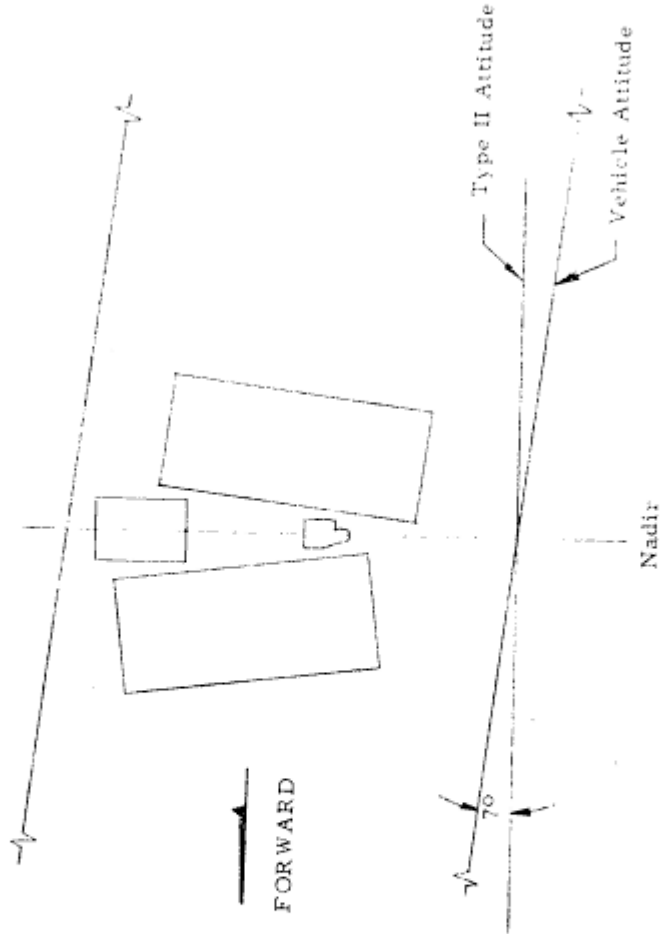

Figure 2-5. Q-Bay Package Type II and Vehicle Attitude Relationships, Caged Condition



ADDENDUM

A - 12 FLIGHT HANDBOOK

- 2-13. During a normal mission-run, the package is expected to cage and uncage possibly more than once due to vehicle attitude perturbations that exceed the platform caging limits.
- 2-14. Type II - Operation.
- 2-15. The Type II package does not operate continuously throughout the entire mission. The package may be operated continuously for a portion of the mission, or it may be operated intermittently for an extended portion of the mission. The flight plan will normally indicate the exact operating procedure.
- 2-16. The package will operate properly and should be operated when required either in a caged condition or an uncaged condition. Best photographic performance, however, can be expected in the uncaged, self-stabilized mode. When the package is being operated in the caged condition, vehicle attitude rates directly affect the photographic performance. Vehicle flight should be kept as smooth as possible and changes in vehicle attitude should be accomplished as smoothly as possible. This will minimize photographic degradation.



ADDENDUM

A-12 FLIGHT HANDBOOK

- 2-17. Two typical Type II mission profiles are shown in Figure 2-6. Mission 1 shows continuous operation of the package for a segment of the entire mission. Mission 2 shows intermittent operation of the package for arbitrary portions of the mission. During initial ascent after refuel, turn HEATER switch to ON position. Specific flight instructions will determine when the RECORD switch is to be turned to the ON position as shown in Figure 2-6.
- 2-18. The Q-BAY EQUIPMENT OUT indicator (red) on the warning light panel, center console, will light in the event of package failure. Should the failure light illuminate, turn RECORD switch to OFF position. Wait approximately 1 minute, and return RECORD switch to ON. If failure light comes on again, turn RECORD and HEATER switches to OFF.
- 2-19. Ideally, a mission-run will be flown in a great circle route; the Type II package will operate in an uncaged condition all of the way; the mission flight path will be exactly as expected; the photographic results will include the area of earth desired.



ADDENDUM
A-12 FLIGHT HANDBOOK

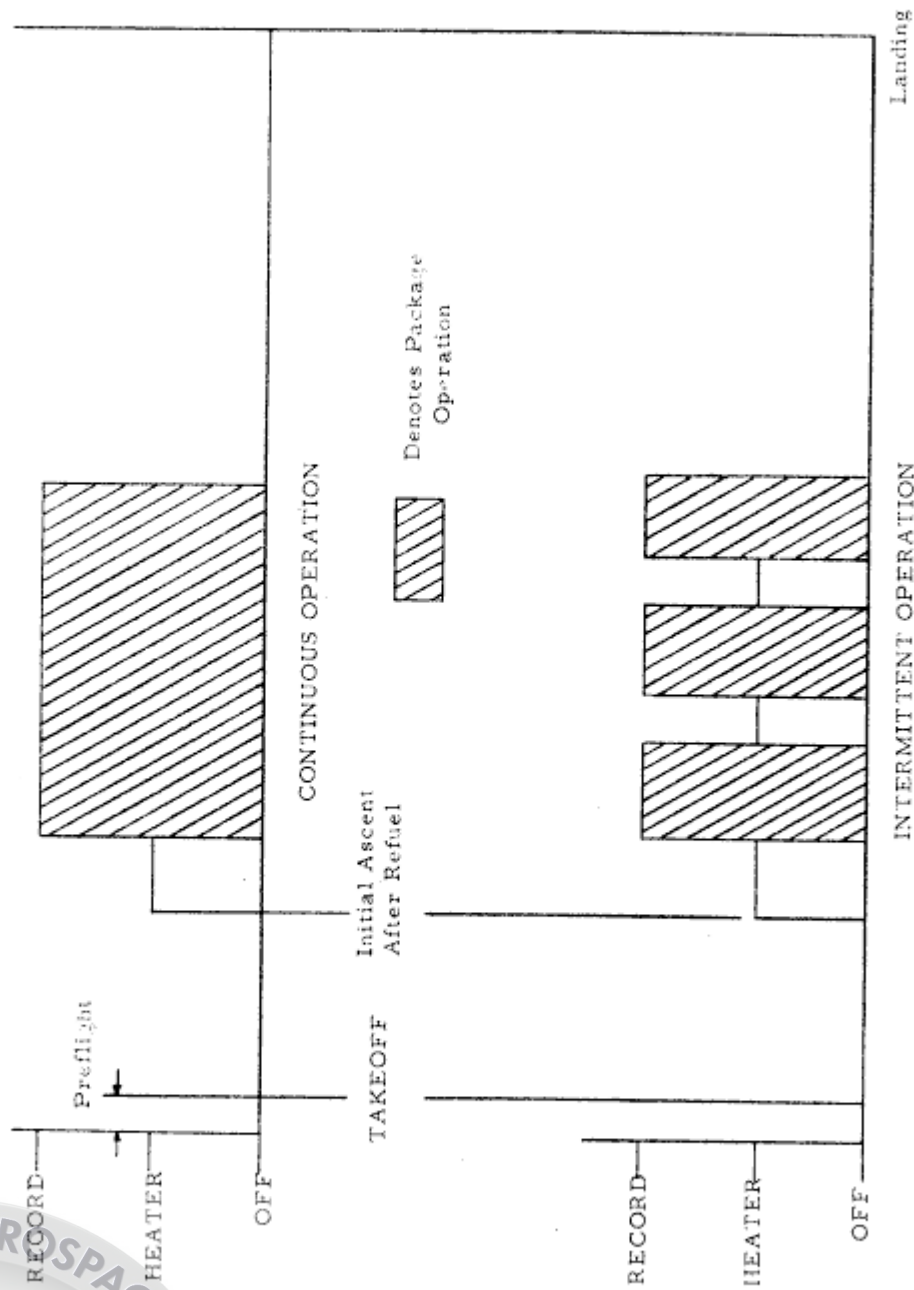
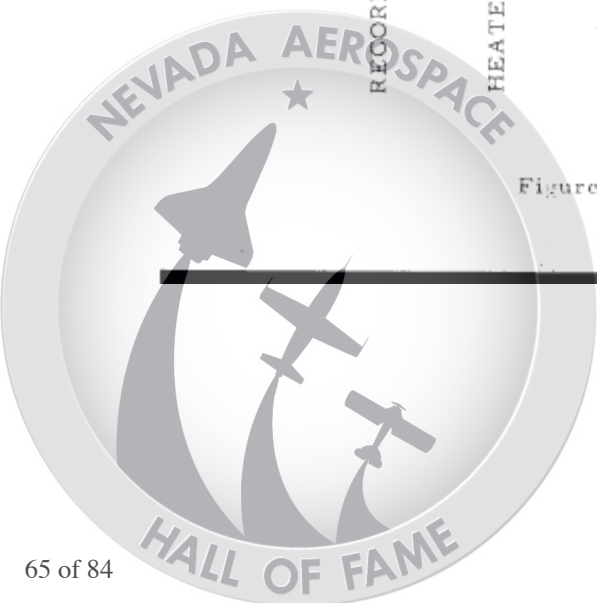

Figure 2-6. Typical Type II Mission Profiles



ADDENDUM

A-12 FLIGHT HANDBOOK

- 2-20. The earth below the vehicle and extending to 25 to 31 miles on either side is being photographed when the vehicle is at minimum to maximum altitude. When the flight path is not as expected, it is better in terms of photographic performance to continue without flight path correction -- a "direct hit" not being important as far as obtaining the necessary photographic coverage.
- 2-21. Caged operation, however, requires the utmost attention. Vehicle attitude rates must be kept low; the vehicle must fly as smoothly as possible to minimize photographic degradation.
- 2-22. If photography with the aid of the periscope wide field is desired, system operation, in most cases, will be programmed according to time and earth coordinates. However, circumstances could be that the operator is responsible for determining photographic coverage through use of the periscope.
- 2-23. If an object to be photographed appears on the periscope, turn RECORD switch to RECORD position. Photography will take place after a one minute delay period.



ADDENDUM

A-12 FLIGHT HANDBOOK

- 2-24. Results of the Type II camera systems are panoramic photographs as shown in Figure 2-7. Photographs from the forward camera and corresponding photographs from the aft camera are aligned as shown also in Figure 2-7, along with the associated data information recorded alongside of each frame. Approximately 1414 photographs with recorded data can be expected from a full film supply of 4200 feet from each camera. Film width is 7.95 inches. Individual frame dimensions are 7.5 inches by 34.23 inches.
- 2-25. Latitude, longitude, timing track, principal point, mission number, date, caging signal, aircraft attitude and camera unit numbers are recorded for each frame in a predetermined code form.



ADDENDUM
A-12 FLIGHT HANDBOOK

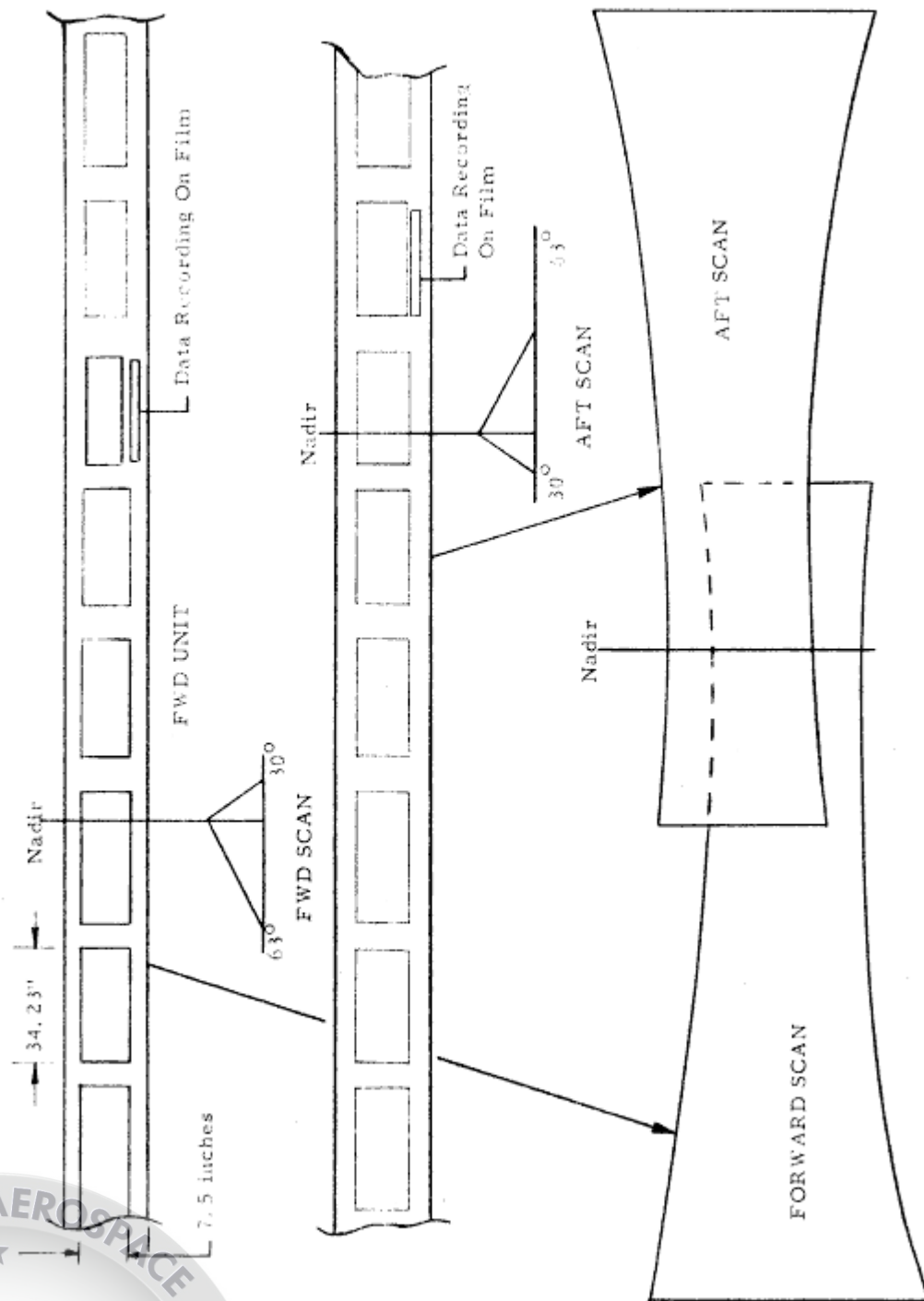
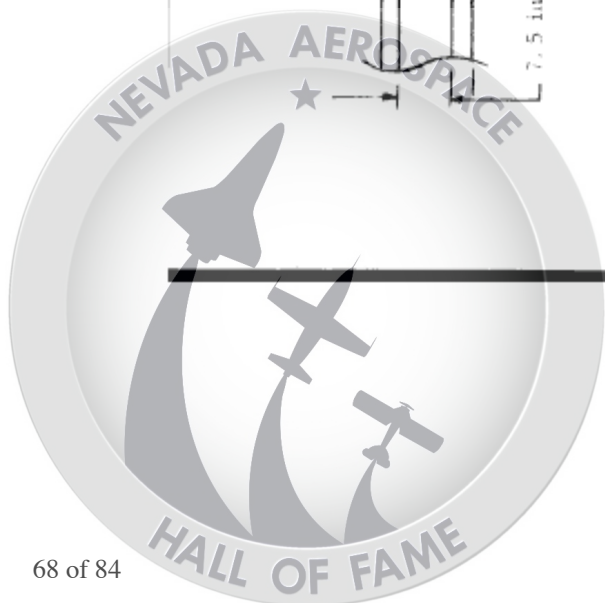

Figure 2-7. Type II Package Format Relationship To Ground Coverage Pattern



ADDENDUM

A - 12 FLIGHT HANDBOOK

- 3-1. Type III - General.
- 3-2. The Type III equipment bay package is an aerial camera system with the mission of obtaining photographs of the earth from an airborne vehicle. The camera system photographs the earth transverse to the vehicle line of flight. A single camera is utilized that sweeps laterally to take photographs in five basic positions -- two right oblique, one vertical and two left oblique.
- 3-3. Photographic coverage of the camera system is represented in Figure 3-1. There are two distinct modes of operation with the Type III package. Mode 1 sweeps continuously through the five basic positions while mode 2 photographs continuously at the same rate, however, in a vertical position only. Mode 1 covers approximately 60° each side of nadir. Mode 2 covers 14° each side of nadir. Each mission can provide 2850 nautical miles flight line coverage on 3900 frames and 51 to 55 nautical miles (or approximately 120°) of total transverse coverage. The scan overlap provides stereo viewing approximately 53° each side of nadir or an approximate total of 106° . See Figure 3-1.



APPENDIX
A-12 FLIGHT HANDBOOK

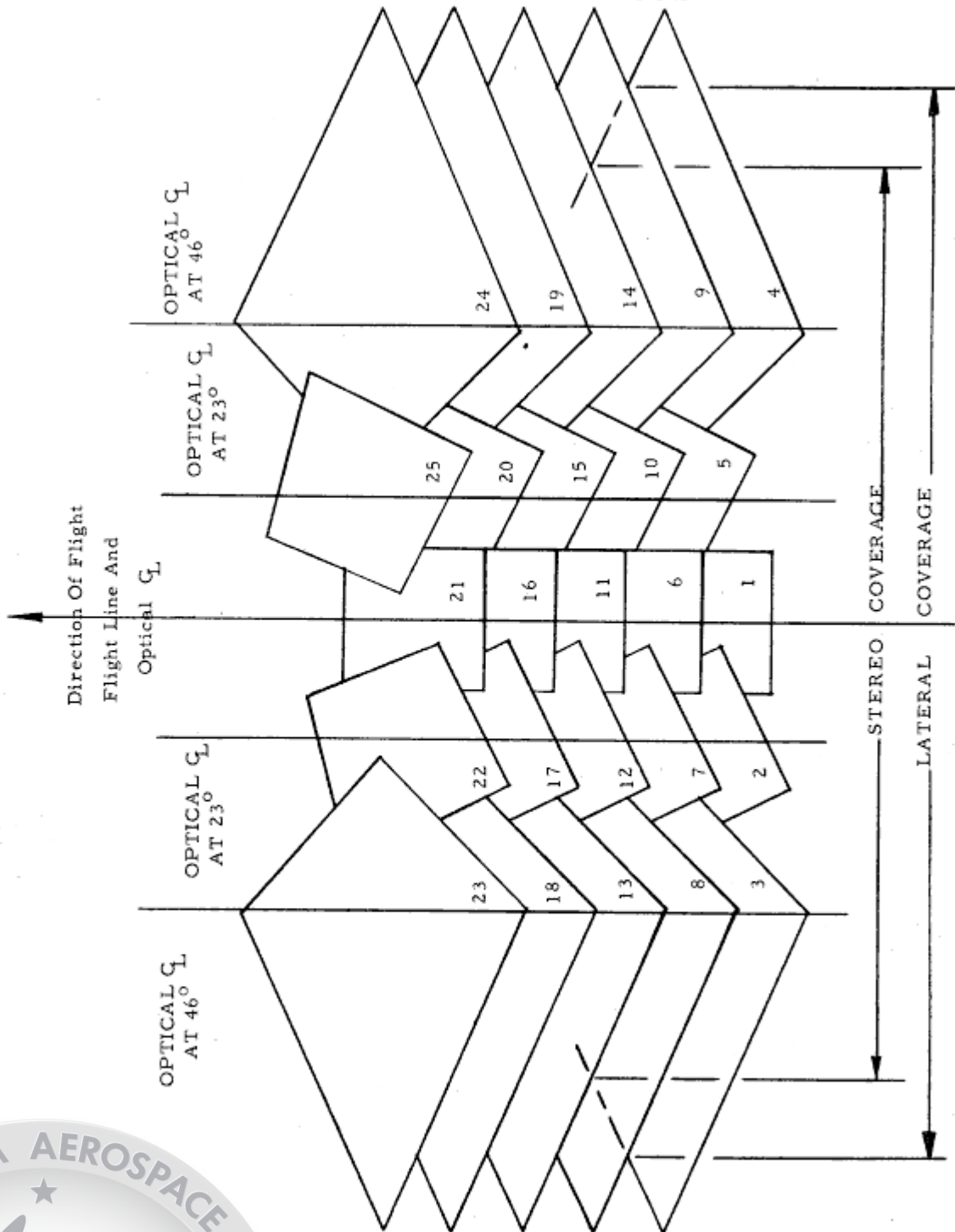
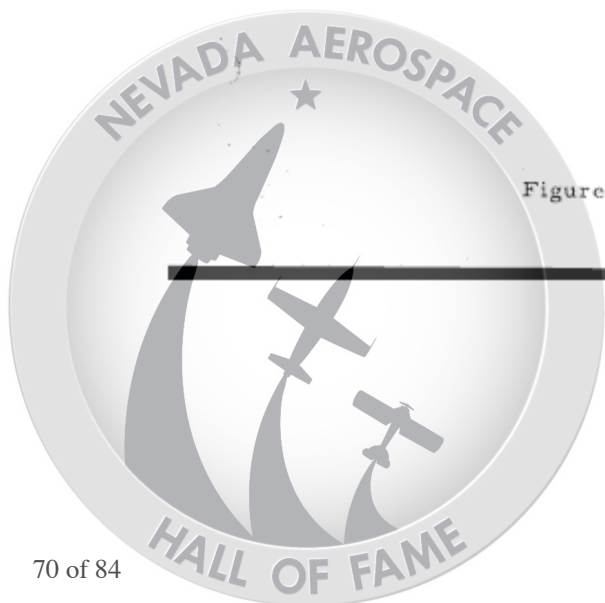

Figure 3-1. Ground Coverage Format, Straight and Level Flight, Type III



ADDENDUM

A-12 FLIGHT HANDBOOK

- 3-4. The Type III package consists of a single assembly which mounts directly to the vehicle through vibration isolators. See Figure 3-2.
- 3-5. The control panel for the Type III package is shown in Figure 3-3. The control panel is located on the left cockpit console, and occupies an area approximately 6 inches by 3 inches.
- 3-6. The two position POWER switch when turned to the ON position provides power to the camera, but will not start operation until SCAN (mode 1) or VERTICAL (mode 2) position is selected on OPERATE switch. The STANDBY position of the OPERATE switch is to be selected when camera operation is not desired.
- 3-7. The package utilizes 28 volt D. C. electrical power from the Essential D. C. Bus.
- 3-8. The package is installed in the vehicle such that it is level when the vehicle is in a nominal cruise attitude of $+7^{\circ}$ in pitch.



ADDENDUM
A-12 FLIGHT HANDBOOK

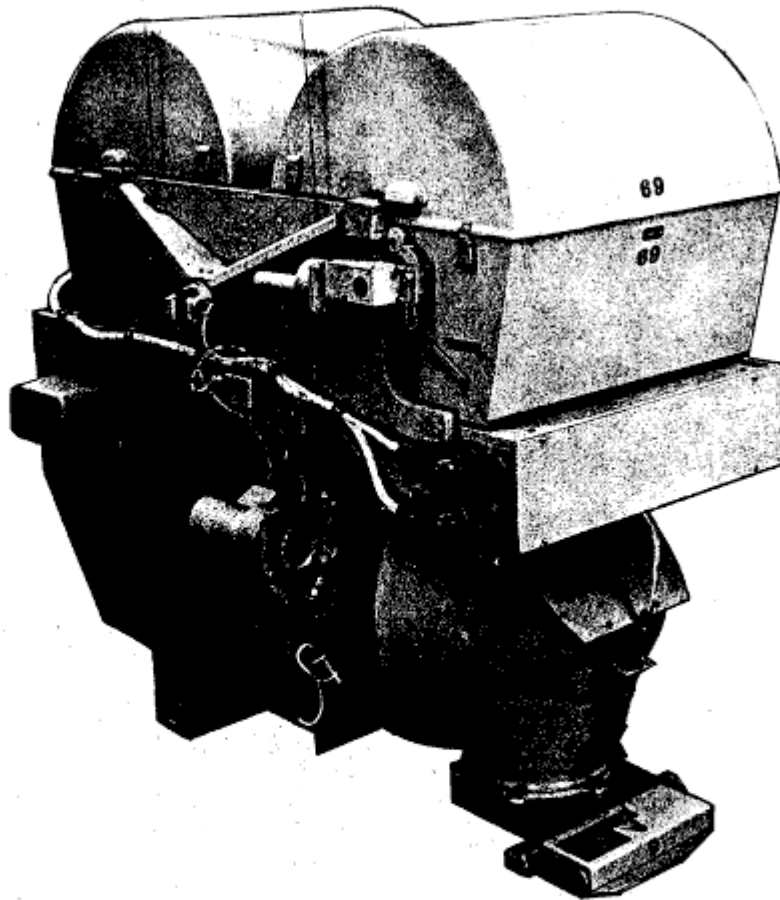

Figure 3-2. Q-Bay Package Type III Physical Description



ADDENDUM
A-12 FLIGHT HANDBOOK

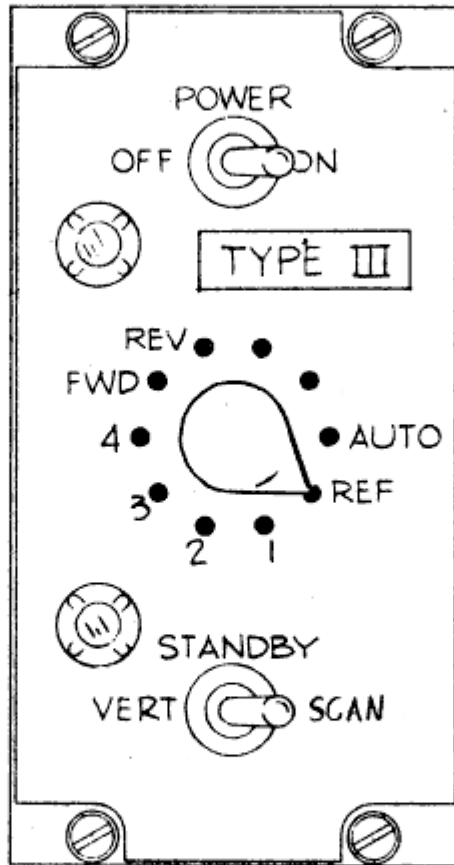
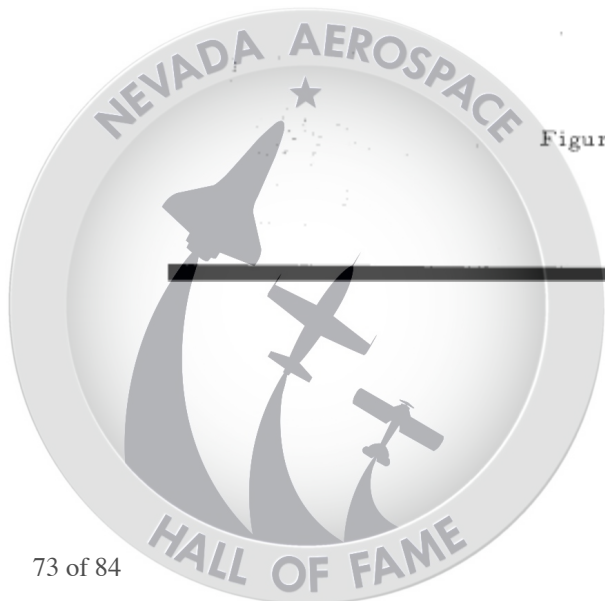

Figure 3-3. Type III Control Panel



ADDENDUM

A - 12 F LIGHT HANDBOOK

- 3-9. Type III - Operation.
- 3-10. The Type III package does not operate continuously throughout the entire mission. The package may be operated continuously for a portion of the mission, or it may be operated intermittently for an extended portion of the mission. The flight plan will normally indicate the exact operating procedure.
- 3-11. Vehicle flight should be kept smooth and changes in vehicle attitude should be accomplished as smoothly as possible. This will minimize photographic degradation.
- 3-12. Two typical Type III mission profiles are shown in Figure 3-4. Mission 1 shows continuous operation of the package for a segment of the entire mission. Mission 2 shows intermittent operation of the package for arbitrary portions of the mission. In practice, the package will always be placed in the STANDBY position at some point during the final pre-flight check and will remain there until the start of the mission.
- 3-13. The Q-BAY EQUIPMENT FAILURE indicator (red) on the warning panel, center console, will light in the event of package failure.



ADDENDUM
A-12 FLIGHT HANDBOOK

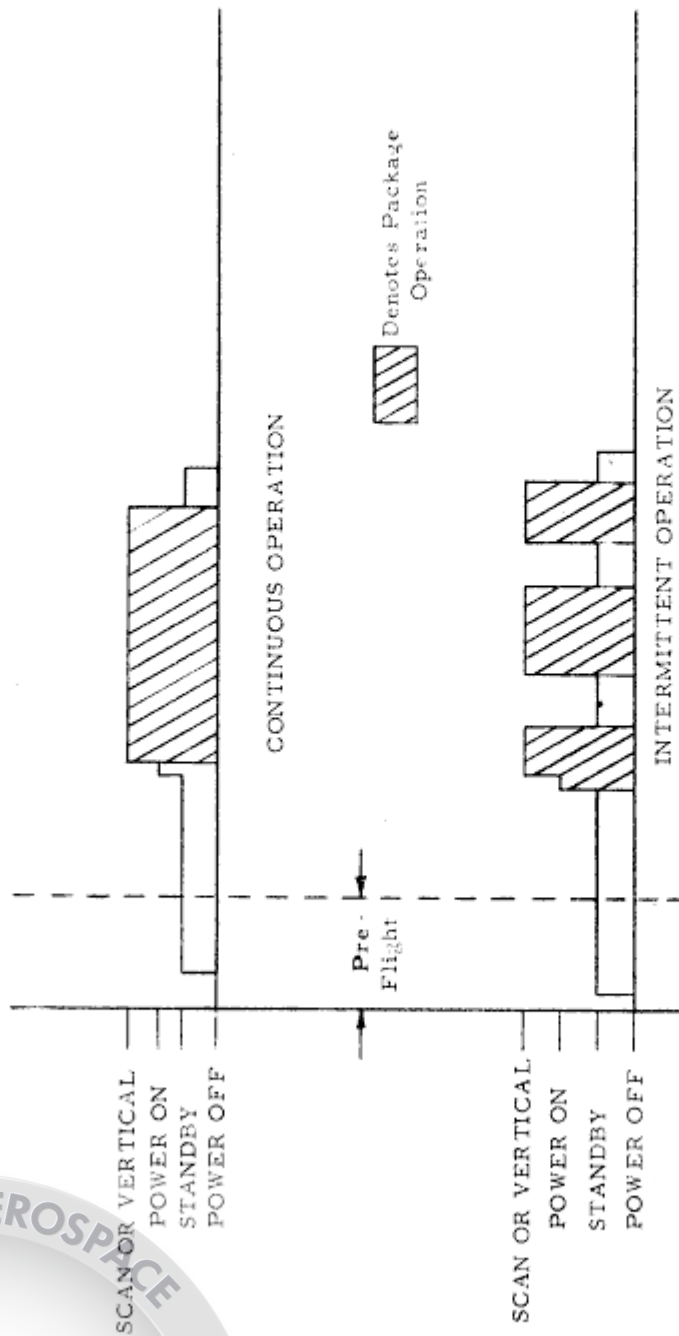

Figure 3-4. Typical Type III Mission Profile



ADDENDUM
A - 12 FLIGHT HANDBOOK

- 3-14. Should the Type III package fail during normal operation, the following procedure is recommended :
- a. Place the OPERATE switch to STANDBY. The Q-BAY EQUIPMENT FAILURE light on the warning panel will go out.
 - b. Wait 15 seconds.
 - c. Place OPERATE switch to VERTICAL or SCAN positions. If failure light comes on again, turn OPERATE switch to STANDBY, wait 15 seconds minimum, and then turn POWER switch to OFF.
- 3-15. Ideally, a mission-run will be flown in a great circle route; the Type III package will operate satisfactorily all the way; the mission flight path will be exactly as expected; the photographic results will include the area of the earth desired.
- 3-16. The earth below the vehicle and extending 25 to 28 nautical miles on either side is being photographed when the vehicle is at minimum to maximum altitudes. When the flight path is not as expected, it is better in terms of photographic performance to continue without flight path correction -- a "direct hit" not being important as far as obtaining the necessary photographic coverage.



ADDENDUM

A - 12 FLIGHT HANDBOOK

- 3-17. If photography with the aid of the periscope wide field is desired, system operation, in most cases, will be programmed according to time and earth coordinates. However, circumstances could be that the operator is responsible for determining photographic coverage through the use of the periscope.
- 3-18. If an object to be photographed appears on the periscope, turn OPERATE switch to SCAN or VERTICAL positions and photography starts immediately.
- 3-19. Results of the Type III camera are sets of photographs in the format shown in Figure 3-1. Each frame contains recorded data and identification of frame position, i. e., one through five. Approximately 3900 photographs with recorded data can be expected from a full film supply of 6000 feet. Individual frame size is 18 inches by 18 inches.
- 3-20. Mission number, time, date and frame position are recorded for each frame.



ADDENDUM

A-12 FLIGHT HANDBOOK

2-7. The control panel consists of two switches -- a RECORD switch and a HEATER switch. The RECORD position of the RECORD switch places the package in the photographic mode and the following events normally occur :

- (1). The system "starts up". Film is transported through each camera, all phasing and synchronism of components occur and photography takes place.
- (2). The system will uncage if the vehicle attitude is within discrete attitude limits.

or

- (3). The system will remain caged if the vehicle attitude is not within discrete attitude limits.

2-8. The Type II package is dynamically influenced by the vehicle under normal conditions in two ways :

- (1) Power inputs and (2) vehicle attitude.

2-9. The package normally derives its power from inverter number 2. Power requirements and input configurations are such that operation of the package should not be affected by the loss of one engine or by switching inverters.

3-1

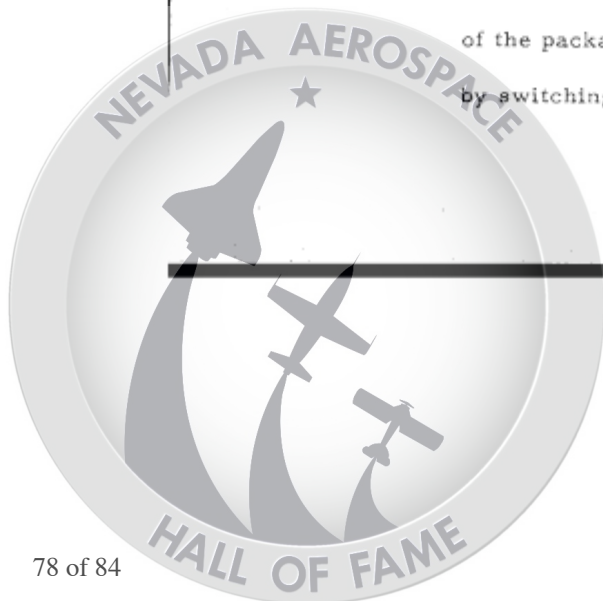

ADDENDUM

A-12 FLIGHT HANDBOOK

- 2-10. Photographic performance of the package depends upon platform attitude. Platform attitude should be level in pitch and roll and parallel in azimuth with the vehicle line of flight. The package is installed in the vehicle such that in the caged condition the platform is level in pitch and roll when the vehicle is at nominal cruise attitude of $+7^{\circ}$ in pitch and 0° in roll. See Figure 2-5.
- 2-11. The package will uncage in the operate mode only when the rate gyro senses rate changes of less than a predetermined number of degrees per second.
- 2-12. In the uncaged condition, the package will stabilize with respect to rate and verticality and will automatically align itself with respect to the vehicle flight path. The package will remain uncaged and stabilize within the following vehicle attitude limits.

Pitch	$7^{\circ} \pm 3 \frac{1}{3}^{\circ}$
Roll	$0^{\circ} \pm 3^{\circ}$
Yaw	$0^{\circ} \pm 2^{\circ}$

The package frame physically prevents the stabilized platform from exceeding the above limits. When any limit has been reached, a corresponding clearance switch will close and cage the platform.



ADDENDUM
A-12 FLIGHT HANDBOOK

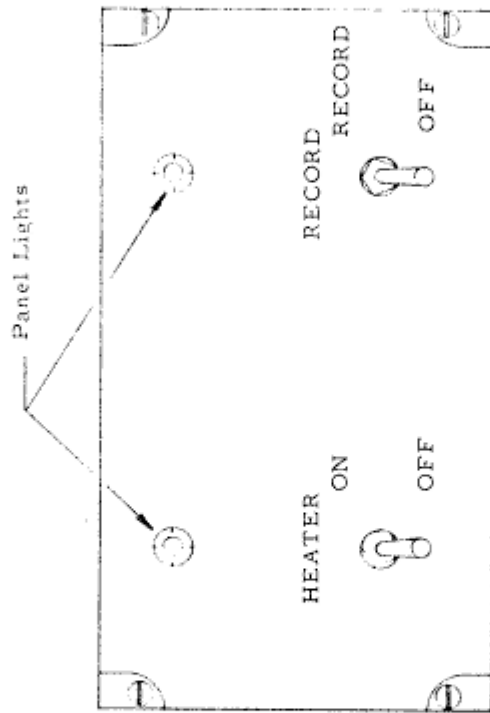

Figure 2-4. Type II Control Panel



ADDENDUM

A-12 FLIGHT HANDBOOK

- 1-25. The Q-BAY EQUIPMENT OUT indicator (red) on the warning light panel, center console, will light in the event of package failure. The package failure indication on the warning light panel can only occur when the status switch is in the OPR position. When a payload failure occurs, the package will automatically switch from the operate mode to the standby 2 mode, the green OPR indicator will go out and the amber STBY 2 light will light.
- 1-26. Should the Type I package fail during normal operation, the following procedure is recommended:
- a. Place the STATUS switch from the OPR position to the STBY 2 position. The Q-BAY EQUIPMENT OUT light on the warning panel will go out. On the control panel, the amber STBY 2 light will continue to light.
 - b. Wait 15 seconds.
 - c. Place STATUS switch to OPR position. One of three possible indications will occur:
 - (1). If the Q-BAY EQUIPMENT OUT light lights immediately, place the STATUS switch to the OFF position.



ADDENDUM

A-12 FLIGHT HANDBOOK

(2). If the Q-BAY EQUIPMENT OUT light does not light immediately, but does light after a noticeable time (approximately 3 to 30 seconds) return the STATUS switch to STBY 2 position and wait 15 seconds. Then place the STATUS switch to the OPR position and observe the Q-BAY EQUIPMENT OUT indicator. If the indicator lights, then the STATUS switch should be placed in the OFF position.

or

(3). If the Q-BAY EQUIPMENT OUT light does not light within 30 seconds, then the package can be considered operational.

1-27. All three control panel indicators are of the press-to-test type. All three indicators should be checked during the pre-flight checkout.

1-28. Ideally, a mission-run will be flown in a great circle route; the Type I package will operate in an uncaged condition all of the way; the mission flight path will be exactly as expected; the photographic results will include the area of earth desired.



ADDENDUM

A-12 FLIGHT HANDBOOK

- 1-29. However, circumstances may be during a mission-run that the flight path is not as expected or the package has been operating caged most of the way.
- 1-30. Caged operation, however, requires the utmost attention. Vehicle attitude rates must be kept low; the vehicle must fly as smoothly as possible to minimize photographic degradation.
- 1-31. If photography with the aid of the periscope wide field is desired, system operation, in most cases, will be programmed according to time and earth coordinates. However, circumstances could be that the operator is responsible for determining photographic coverage through use of the periscope.
- 1-32. If an object to be photographed appears on the periscope wide field at a time when the Type I package is in the STBY 2 mode, the package must be placed into the OPERATE mode within 20 seconds after the object's first appearance on the periscope wide field. If the STATUS switch is not placed to the OPR position within the object's first 20 seconds of visibility on the periscope then the object will probably not be within the photographic field of view during the time of photography.



ADDENDUM

A-12 FLIGHT HANDBOOK

- 1-33. Results of the Type I camera system are matched sets of panoramic photographs in the format shown in Figure 1-10. Paired photographs, one forward scan and the corresponding aft scan, appear with the associated data information recorded in an area between them. Approximately 990 such paired photographs with recorded data can be expected from a full film supply of 5000 feet. Film width is 6.6 inches. Individual frame dimensions are 6.4 inches by 27.8 inches.
- 1-34. Vehicle ground speed, latitude, longitude, Greenwich Mean Time, and the mission flight number are recorded for each frame. See Figure 1-11. A caged status indication is also provided for, indicating whether the Q-Bay package was caged or uncaged for any particular frame.

